



## PRODUCT SELECTION MANUAL

**乐清市博实电塑有限公司**  
Yueqing Boese Electronic Plastic Co., Ltd.



## BRIEF INTRODUCTION

### 公司简介

**General Manager:** MR ZHAO  
**Found Date:** Jan.2006  
**Registration Fund:** RMB3,000,000  
**Workshop Area:** 4600 m<sup>2</sup>  
**Employee:** 100

**Main Equipment:** 30 large-scale full computerized injection mold machines, and 6 testing consoles.

**Main products:** self-locking nylon cable ties, Marker ties and other kind of nylon cable ties, cable glands, cable clips, terminal blocks, insulated terminals, screw on wire connectors, tie mounts, and other wire accessories.

**Certificate:** The company passed ISO9001 International Quality System Attestation. The products passed TUV Attestation, CE Attestation, ROHS Attestation.

**Team Work:** We have senior engineers and management team work, who make their efforts to promote technical know-how & management to the best cooperation between technique, production, accessories purchasing, sales. Solid technical power, superior equipment and advanced craftsmanship get approval and reliance from the same line and clients.

**Our mission:** Since the establishment of the company, we have been committed to the development and research in the field of wire accessories. Although our company is still very young, but more than ten years we always maintain enthusiasm and momentum. The market of cooperation is increasing, and the demand of customers is also increasing. We continue to improve quality and service to match the different requirements of the global market. We believe that we and our partners are mutually beneficial.



# BRIEF INTRODUCTION

## 公司简介

创建日期：2006年1月

注册资金：人民币300万元

厂房面积：4600平方米

员工人数：100人

主要设备：全电脑大型注塑机30台，检测台6台

主要产品：自锁式尼龙扎带，标牌式扎带和其它各式尼龙扎带，电缆固定头，钢钉线卡，接线端子，绝缘端子，螺旋式压线帽，定位片等电缆附件。

资格证书：已通过ISO9001质量体系认证，产品通过了TUV, CE, ROHS, UL认证。

团队建设：公司拥有一支资深技术、管理团队，致力于提高企业管理水准，使技术、生产、质量、采购、销售等环节达到最佳配合优化状态。本公司技术力量雄厚、设备精良、工艺先进，深受广大同行和客户的肯定和信赖。

# CERTIFICATIONS

## 资质证书



# PLANT EQUIPMENT

## 工厂设备

Dedication, Integrity, Innovation  
敬业、诚信、创新



# PRODUCT LIST

## 产品目录

01-29

- Self Locking Nylon Cable Tie
- Cable Tie Tools
- Releasable Cable Tie
- Beaded Releasable Cable Tie
- Nylon Metal Barb Tie
- Marker Cable Tie
- Mountable Head Tie
- Double Loop Cable Tie
- Handcuff Tie
- Expand Plug Cable Tie
- Plastic Seals
- Antiskid Ties
- Magic Cable Tie

30-46

- Push Mount Ties
- Edge Clip With Cable Tie
- Stainless Steel Cable Ties
- Stainless Steel PVC Coated Ties
- Stainless Steel Epoxy Coated Cable Ties
- Fish Bone Shape Head Ties

47-53

- Circle Cable Clip
- K-type Circle Cable Clip
- Flat Cable Clip
- Hook Cable Clip
- Metal Fire Resistant Cable Clip
- Plastic Pipe Clamp





54-57

- Nylon Cable Gland
- Metal Cable Gland

58-72

- Cable Tie Mount
- Adjustable Cable Clamp
- Cable Clamp
- Cable Tie Holder
- Spiral Wrapping Bands

73-82

- R type Cable Clamp
- Expand Plugs
- Safety type Wire Joints
- Screw On Wire Connectors
- Double Wings Screw On Wire Connectors
- Heat Shrinkable Tubings
- Vinyl Wire End Caps
- Terminal Block
- Terminal





# Nylon Cable Tie Series

尼龙扎带系列





## 自锁式尼龙扎带

### Self Locking Nylon Cable Tie

Material: 材质:	Nylon66(UL) 尼龙 66
Flame Class: 防火等级:	94V-2
Working Temperature: 适用温度范围:	-40℃ ~85℃
Color: 颜色:	Natural,black,UV black,other colors are available as requested. 本色、黑色,抗紫外线之黑色。 特殊颜色均可定做。



### •描述 Description

电缆扎带用于许多行业:电气安装,线束制作,建筑行业,用于初步安装,包装行业或在极端环境条件下,如海上工业。

可抗紫外线。耐酸、耐蚀、绝缘性好、不易老化、承受能力强。

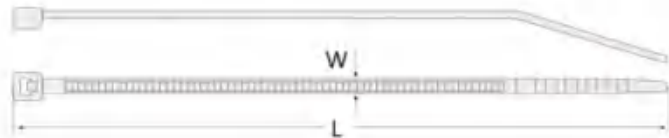

Cable ties are used in many industries: in the electrical installation, in harness making, in the construction industry, for preliminary installation purposes, in the packaging industry or under extreme environmental conditions like in the offshore industry.

UV-resistant, Acid & erosion control, insulate well and not easy to aging, tensile strong.

#### MINIATURE RANGE CABLE TIES: 2.5mm WIDTH



standard range colour: Black  or Natural

Item No.	Width	Length		Max.Bundle Dia.	Min.Tensile Strength	
	mm	mm	Inch	mm	Lbs	kgs
BS-2.5x80	2.5	80	3.15 "	16	18	8
BS-2.5x100		100	4 "	22		
BS-2.5x120		120	4.72 "	22		
BS-2.5x150		150	6 "	35		
BS-2.5x200		200	7.87 "	50		



**INTERMEDIATE RANGE CABLE TIES: 3.6mm WIDTH**



standard range colour: Black  or Natural

Item No.	Width	Length		Max.Bundle Dia.	Min.Tensile Strength	
	mm	mm	Inch	mm	Lbs	kgs
BS-3.6x150	3.6	150	6 "	35	40	18
BS-3.6x180		180	7.09 "	42		
BS-3.6x200		200	7.87 "	50		
BS-3.6x250		250	9.84 "	65		
BS-3.6x300		300	11.81 "	80		
BS-3.6x350		350	13.78 "	80		
BS-3.6x370		370	14.57 "	102		
BS-3.6x400		400	15.75 "	103		

**STANDARD RANGE CABLE TIES: 4.8mm WIDTH**



standard range colour: Black  or Natural

Item No.	Width	Length		Max.Bundle Dia.	Min.Tensile Strength	
	mm	mm	Inch	mm	Lbs	kgs
BS-4.8x120	4.8	120	4.72 "	26	50	22
BS-4.8x150		150	5.91 "	35		
BS-4.8x180		180	7.09 "	46		
BS-4.8x200		200	7.87 "	50		
BS-4.8x250		250	9.84 "	65		
BS-4.8x280		280	11 "	70		
BS-4.8x300		300	11.81 "	80		
BS-4.8x350		350	13.78 "	90		
BS-4.8x370		370	14.57 "	102		
BS-4.8x400		400	15.75 "	105		
BS-4.8x450		450	17.72 "	130		
BS-4.8x500		500	19.69 "	150		





**LIGHT HEAVY RANGE CABLE TIES: 7.6mm WIDTH**



standard range colour: Black  or Natural

Item No.	Width	Length		Max.Bundle Dia.	Min.Tensile Strength	
	mm	mm	Inch	mm	Lbs	kgs
BS-7.6x200	7.6	200	7.87 "	50	120	55
BS-7.6x250		250	9.84 "	65		
BS-7.6x300		300	11.81 "	80		
BS-7.6x350		350	13.78 "	90		
BS-7.6x380		380	15 "	102		
BS-7.6x400		400	15.75 "	105		
BS-7.6x450		450	17.72 "	130		
BS-7.6x500		500	20 "	150		
BS-7.6x550		550	21.65 "	160		
BS-7.6x700		700	27.56 "	195		

**HEAVY RANGE CABLE TIES: 9.0mm WIDTH**



standard range colour: Black  or Natural

Item No.	Width	Length		Max.Bundle Dia.	Min.Tensile Strength	
	mm	mm	Inch	mm	Lbs	kgs
BS-9.0x300	9.0	300	11.81 "		175	79.4
BS-9.0x400		400	15.75 "	105		
BS-9.0x450		450	17.72 "	130		
BS-9.0x500		500	19.69 "	150		
BS-9.0x550		550	21.65 "	160		
BS-9.0x600		600	23.62 "	170		
BS-9.0x650		650	25.59 "	185		
BS-9.0x700		700	27.56 "	195		
BS-9.0x750		750	29.53 "	225		
BS-9.0x800		800	31.5 "	230		
BS-9.0x900		900	35.43 "	265		
BS-9.0x1020		1020	39.78 "	300		

**EXTRA HEAVY RANGE CABLE TIES:12mm WIDTH**



standard range colour: Black  or Natural

Item No.	Width	Length		Max.Bundle Dia.	Min.Tensile Strength	
	mm	mm	Inch	mm	Lbs	kgs
BS-12.0x600	12.0	600	23.62	170	250	114
BS-12.0x650		650	25.59	190	250	114

Item No.	Width	Length		Max.Bundle Dia.	Min.Tensile Strength	
	mm	mm	Inch	mm	Lbs	kgs
BS-1.9x100	1.9	100	3.94	22	14	6.5
BS-1.9x150		150	5.91	35		
BS-1.9x200		200	7.87	50		
BS-2.7X250	2.7	250	10	65	33	15
BS-2.7X300		300	11.84	80		
BS-5.2X180	5.2	180	7	42	65	30
BS-5.2X200		200	8	50		
BS-5.2X250		250	10	65		
BS-5.2x300		300	11.84	80		
BS-5.2x400		400	15.75	105		
BS-5.2x500		500	19.69	150		

CABLE TIE SERIES

**•应用场景 Application scenarios**







## 尼龙扎带包装款式 A 系列

### PACKING OF SERIES A

Material: 材质:	Nylon66(UL) 尼龙 66
Flame Class: 防火等级:	94V-2
Working Temperature: 适用温度范围:	-40℃ ~85℃
Color: 颜色:	Natural,black,UV black,other colors are avilable as requested. 本色、黑色,抗紫外线之黑色。 特殊颜色均可定做。



Item No.	PACKAGE	PCS/CTN	WEIGHT	
	CM		NET	GROSS
BS-2.5x80	45X33X32	60000	14	15
BS-2.5x100	45X33X32	50000	14	15
BS-2.5x120	45X33X32	45000	14	15
BS-2.5x150	45X33X32	40000	16	17
BS-2.5x200	45X33X32	30000	16	17
BS-3.6x150	54X33X32	25000	16	17
BS-3.6x180	54X33X32	22000	16	17
BS-3.6x200	54X33X32	20000	17	18
BS-3.6x250	54X33X32	16000	17	18
BS-3.6x300	54X33X32	14000	18	19
BS-3.6x350	54X33X32	13000	20	21
BS-3.6x370	54X33X32	12000	20	21
BS-3.6x400	54X33X32	12000	20	21
BS-4.8x120	45X33X32	15000	17	18
BS-4.8x150	45X33X32	15000	18	19
BS-4.8x180	45X33X32	14000	18	19

Item No.	PACKAGE	PCS/CTN	WEIGHT	
	CM		NET	GROSS
BS-4.8x200	45X33X32	14000	17	18
BS-4.8x250	45X33X32	12000	16	17
BS-4.8x280	45X33X32	11000	17	18
BS-4.8x300	45X33X32	10000	17	18
BS-4.8x350	54X33X32	10000	19	20
BS-4.8x370	54X33X32	10000	20	21
BS-4.8x400	54X33X32	10000	23	24
BS-4.8x450	54X33X32	7000	19	20
BS-4.8x500	54X33X32	5000	17	18
BS-7.6x200	45X33X32	7000	15	16
BS-7.6x250	45X33X32	6000	16	17
BS-7.6x300	45X33X32	5000	17	18
BS-7.6x350	45X33X32	5000	20	21
BS-7.6x380	54X33X32	5000	21	22
BS-7.6x400	54X33X32	5000	22	23
BS-7.6x450	54X33X32	4500	23	24
BS-7.6x500	54X33X32	4500	25	26
BS-7.6x550	65X28X30	3000	17	18
BS-7.6x700	80X28X15	2500	17	18
BS-9.0x300	50X28X30	2000	11	12
BS-9.0x400	50X28X30	2000	12	13
BS-9.0x450	55X28X30	2000	13	14
BS-9.0x500	60X28X30	1000	10	11
BS-9.0x550	65X28X15	1000	10	11
BS-9.0x600	70X28X15	1000	10	11
BS-9.0x650	75X28X15	1000	11	12





Item No.	PACKAGE	PCS/CTN	WEIGHT	
	CM		NET	GROSS
BS-9.0x700	80X28X15	1000	11	12
BS-9.0x750	85X28X15	1000	12	13
BS-9.0x800	90X28X15	1000	12	13
BS-9.0x900	100X28X15	1000	14	15
BS-9.0x1020	112X28X15	1000	16	17

Item No.	PACKAGE	PCS/CTN	WEIGHT	
	CM		NET	GROSS
BS-12.0x600	70X28X15	1000	12	13
BS-12.0x650	75x28x15	1000	13	14

Item No.	PACKAGE	PCS/CTN	WEIGHT	
	CM		NET	GROSS
BS-1.9x100	45X33X32	60000	9	10
BS-1.9x150	45X33X32	50000	13	14
BS-1.9x200	45X33X32	40000	15	16
BS-2.7X250	45X33X32	25000	17	18
BS-2.7X300	45X33X32	20000	17	18
BS-5.2X180	54X33X32	15000	16	17
BS-5.2X200	54X33X32	14000	16	17
BS-5.2X250	54X33X32	12000	17	18
BS-5.2x300	54X33X32	10000	19	20
BS-5.2x400	54X33X32	10000	25	26
BS-5.2x500	54X33X32	5000	15	16

CABLE TIE SERIES

## 尼龙扎带包装款式 B 系列

### PACKING OF SERIES B

Material: 材质:	Nylon66(UL) 尼龙 66
Flame Class: 防火等级:	94V-2
Working Temperature: 适用温度范围:	-40℃ ~85℃
Color: 颜色:	Natural,black,UV black,other colors are available as requested. 本色、黑色,抗紫外线之黑色。 特殊颜色均可定做。



Item No.	PACKAGE	PCS/CTN	WEIGHT	
	CM		NET	GROSS
BS-2.5x80	45X33X32	60000	14	15
BS-2.5x100	45X33X32	50000	14	15
BS-2.5x120	45X33X32	45000	14	15
BS-2.5x150	45X33X32	40000	16	17
BS-2.5x200	45X33X32	30000	16	17
BS-3.6x150	54X33X32	25000	16	17
BS-3.6x180	54X33X32	22000	16	17
BS-3.6x200	54X33X32	20000	17	18
BS-3.6x250	54X33X32	16000	17	18
BS-3.6x300	54X33X32	14000	18	19
BS-3.6x370	54X33X32	12000	20	21
BS-4.8x200	45X33X32	14000	17	18
BS-4.8x250	45X33X32	12000	16	17
BS-4.8x300	45X33X32	10000	17	18
BS-4.8x350	54X33X32	10000	19	20
BS-4.8x370	54X33X32	10000	20	21





Item No.	PACKAGE	PCS/CTN	WEIGHT	
	CM		NET	GROSS
BS-4.8x400	54X33X32	10000	23	24
BS-4.8x450	54X33X32	7000	19	20
BS-4.8x500	54X33X32	5000	17	18
BS-7.6x200	45X33X32	7000	15	16
BS-7.6x250	45X33X32	6000	16	17
BS-7.6x300	45X33X32	5000	17	18
BS-7.6x350	45X33X32	5000	20	21
BS-7.6x380	54X33X32	5000	21	22
BS-7.6x400	54X33X32	5000	22	23
BS-7.6x450	54X33X32	4500	23	24
BS-7.6x500	54X33X32	4500	25	26
BS-7.6x550	65X28X30	3000	17	18
BS-7.6x700	80X28X15	2500	17	18
BS-9.0x400	50X28X30	2000	12	13
BS-9.0x450	55X28X30	2000	13	14
BS-9.0x500	60X28X30	1000	10	11
BS-9.0x550	65X28X15	1000	10	11
BS-9.0x600	70X28X15	1000	10	11
BS-9.0x650	75X28X15	1000	11	12
BS-9.0x700	80X28X15	1000	11	12
BS-9.0x750	85X28X15	1000	12	13
BS-9.0x800	90X28X15	1000	12	13
BS-9.0x900	100X28X15	1000	14	15
BS-9.0x1020	112X28X15	1000	16	17

## 尼龙扎带包装款式 C 系列

### PACKING OF SERIES C

Material: 材质:	Nylon66(UL) 尼龙 66
Flame Class: 防火等级:	94V-2
Working Temperature: 适用温度范围:	-40℃ ~85℃
Color: 颜色:	Natural,black,UV black,other colors are available as requested. 本色、黑色、抗紫外线之黑色。特殊颜色均可定做。



Item No.	Size (mm)	QTY./BOX	Color	Packing
C1-200	2.5x100 4"	50PCS	Green	SIZE:φ5.5x21cm QTY/CTN:70SETS G.W/N.W:10/8KG MEANS: 42x31x48cm
			White	
	2.5x150 6"	50PCS	Blue	
	3.6x200 8"	50PCS	White	
C2-300A	2.5x100 4"	100PCS	White	SIZE:φ7.5x21cm QTY/CTN:40SETS G.W/N.W:13/11KG MEANS: 42x34x46cm
		25PCS	Red	
		25PCS	Yellow	
		25PCS	Blue	
	3.6x200 8"	50PCS	White	
		25PCS	Blue	
		25PCS	Red	
C3-300B	2.5x100 4"	100PCS	White	
		100PCS	Black	
	3.6x200 8"	25PCS	White	
		25PCS	Black	
	4.8x200 8"	25PCS	White	
		25PCS	Black	





Item No.	Size (mm)	QTY./BOX	Color	Packing
C4-400	2.5x100 4"	150OCS	White	SIZE:φ7.5x21cm QTY/CTN:40SETS G.W/N.W:13/11KG MEANS: 42x34x46cm
		150PCS	Black	
	3.6x200 8"	25PCS	White	
		25PCS	Black	
	4.8x200 8"	25PCS	White	
		25PCS	Black	
C5-500	2.5x100 4" 4.8x200 8"	100PCS	Red	SIZE:φ12x22cm QTY/CTN:25SETS G.W/N.W:14/13KG MEANS: 63x63x23cm
		100PCS	Yellow	
		100PCS	Orange	
		100PCS	Blue	
		100PCS	Green	
C6-650	2.5x100 4"	100PCS	Red	SIZE:φ10x22cm QTY/CTN:25SETS G.W/N.W:10/8KG MEANS: 53x53x24cm
		100PCS	Yellow	
		100PCS	Blue	
		100PCS	Green	
	2.5x150 6"	100PCS	White	
		100PCS	Black	
3.6x200 8"	50PCS	White		
C7-850	2.5x100 4"	100PCS	Red	SIZE:φ12x31cm QTY/CTN:16SETS G.W/N.W:11/9KG MEANS: 50x50x33cm
		100PCS	Yellow	
		100PCS	Blue	
		100PCS	Green	
		100PCS	White	
	3.6x200 8"	100PCS	White	
		200PCS	Black	
	3.6x300 12"	50PCS	White	

CABLE TIE SERIES

Item No.	Size (mm)	QTY./BOX	Color	Packing
C8-1000	2.5x100 4"	200PCS	White	SIZE:φ12x31cm QTY/CTN:15SETS G.W/N.W:11/9KG MEANS: 64x38x33cm
		200PCS	Black	
		50PCS	Blue	
		50PCS	Red	
		50PCS	Yellow	
		50PCS	Green	
	2.5x150 6"	50PCS	White	
		50PCS	Black	
		50PCS	Blue	
		50PCS	Yellow	
	3.6x200 8"	50PCS	White	
		50PCS	Black	
	3.6X300 12"	50PCS	White	
		50PCS	Black	
C9-1000+1	2.5x100 4"	200PCS	White	SIZE:φ12x31cm QTY/CTN:15SETS G.W/N.W:11/9KG MEANS: 64x38x33cm
		200PCS	Black	
		50PCS	Blue	
		50PCS	Red	
		50PCS	Yellow	
		50PCS	Green	
	2.5x150 6"	50PCS	White	
		50PCS	Black	
		50PCS	Blue	
		50PCS	Yellow	
	3.6x200 8"	50PCS	White	
		50PCS	Black	
	3.6X300 12"	50PCS	White	
		50PCS	Black	
	BST-100TIE GUN	1PCS	Blue	





## 尼龙扎带包装款式 D 系列

### PACKING OF SERIES D

Material: 材质:	Nylon66(UL) 尼龙 66
Flame Class: 防火等级:	94V-2
Working Temperature: 适用温度范围:	-40℃ ~85℃
Color: 颜色:	Natural,black,UV black,other colors are available as requested. 本色、黑色、抗紫外线之黑色。 特殊颜色均可定做。



Item No.	Size (mm)	QTY./BOX	Packing
D1-75	2.5x100 4"	25PCS	"QTY/CTN:250 SETS G.W/N.W:17/15KG MEANS:54X33X32cm"
	2.5x150 6"	25PCS	
	3.6x200 8"	25PCS	
D2-60	2.5x100 4"	20PCS	"QTY/CTN:250 SETS G.W/N.W:17/15KG MEANS:54x33x32cm"
	3.6x150 6"	20PCS	
	4.8x200 8"	20PCS	
D3-100	2.5x100 4"	30PCS	"QTY/CTN:144SETS G.W/N.W:15/13KG MEANS:49x33x32cm"
	3.6x150 6"	40PCS	
	3.6x200 8"	30PCS	
D4-100	2.5x100 4"	40PCS	"QTY/CTN:40SETS G.W/N.W:6/5KG MEANS:38x30x36cm"
	3.6x150 6"	30PCS	
	3.6x200 8"	30PCS	
D5-200	2.5x100 4"	200PCS	"QTY/CTN:40SETS G.W/N.W:6/5KG MEANS:38x30x36cm"
D6-120	2.5x100 4"	40PCS	"QTY/CTN:80SETS G.W/N.W:13/11KG MEANS:45.5X30X43cm"
	2.5x150 6"	40PCS	
	3.6x200 8"	40PCS	
D7-75	2.5x100 4"	25PCS	"QTY/CTN:80SETS G.W/N.W:8/7KG MEANS:45x30x40cm"
	2.5X120 4.7"	25PCS	
	3.6X300 8"	25PCS	
D8-200	2.5x100 4"	200PCS	"QTY/CTN:40SETS G.W/N.W:6/5KG MEANS:38x30x36cm"

## 扎带枪

### Cable Ties Tools

#### •描述 Description

##### TG-100

将束带拉紧并切断，适用束带宽度为 2.4-4.8mm

For tensioning and cut-off cable tie from width  
2.4mm to 4.8mm  
FOR "DIY" ONLY



#### •描述 Description

##### BS-600A

适用于尼龙扎带宽度：2.4-4.8mm 以下 6.3"(160mm)  
适用于快速捆扎电缆电线，自动切断扎带剩余部分捆  
切合二为一，可用的塑料扎带  
长 50-350mm，线宽 4.8mm 以下  
重量：0.30KG 长度：165mm 材质：金属制

Suitcable for fastbind wire and cable automatic  
cut-and-bind left part  
Deviding cable tie 50-350mm, its width 4.8mm  
Weight: 0.30kg L: 165mm Material: Metal



#### •描述 Description

##### BS-519

适用于尼龙扎带宽度：2.4-4.8mm 以下 6.3"(160mm)  
适用于快速捆扎电缆电线，自动切断扎带剩余部分捆  
切合二为一，可用的塑料扎带  
长 50-350mm，线宽 4.8mm 以下  
重量：0.30KG 长度：165mm 材质：金属制

Suitcable for fastbind wire and cable automatic  
cut-and-bind left part  
Deviding cable tie 50-350mm, its width 4.8mm  
Weight: 0.30kg L: 165mm Material: Metal







## 可松式尼龙扎带

### Releasable Cable Tie

Material: 材质:	Nylon66(UL) 尼龙 66
Flame Class: 防火等级:	94V-2
Working Temperature: 适用温度范围:	-40℃ ~85℃
Color: 颜色:	All colors are available 所有颜色均可定制



### •描述 Description

中等重量负载的可松和可重复使用的电缆扎带，极易操作的可松方式，只需单手即可简单快速地打开，也可在 PA66W 户外应用，REL 电缆扎带内部有锯齿。

Releasable and reusable cable tie for medium-weight loads, Extremely easy-to-operate release mechanism, Opens simply and quickly with only one hand, Also available in PA66W for outdoor applications, REL cable ties have their serration on the inside

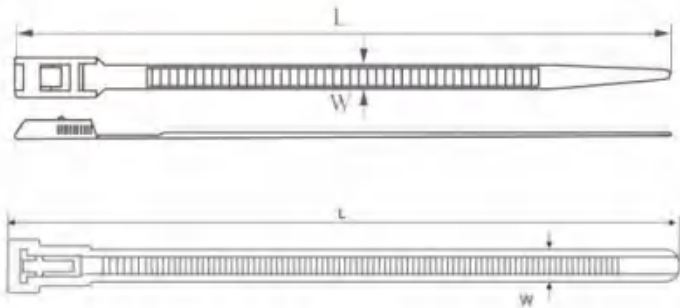

Item No.	Width	Length		Max.Bundle Dia.	Min.Tensile Strength	
	mm	mm	Inch	mm	Lbs	kgs
BS-150RT	7.2	150	6"	35	50	22
BS-200RT		200	8"	45		
BS-250RT		250	10"	60		
BS-300RT		300	12"	75		
BS-350ROT	8	359	14.1	90	50	22
BS-400ROT		400	15.8	105		
BS-450ROT		450	17.7	118		

### •细节图 Detail pictures



## 串珠可退式尼龙扎带

Beaded releasable Cable Ties

Material: 材质:	PA66(UL) 尼龙 66
Flame Class: 防火等级:	94V-2
Working Temperature: 适用温度范围:	-40℃ ~85℃
Color: 颜色:	All colors are available 所有颜色均可定制



### •描述 Description

锁定的头部使它们易于安装，拆卸和重新调整。  
非常适合用在临时或需要频繁更新的物件上。  
可做电缆标识牌。带身上的圆形珠子不会卡住或损坏电缆或周围的绝缘物。

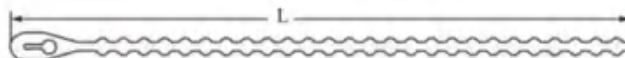

Locking key head makes them easy to install, remove, and re-adjust.

Perfect for applications that are temporary or require frequent updating.

Compatible with cable ID plates.

The smooth rounded beads on the ties won't snag or harm your cabling or the insulation surrounding them.

Item No.	Length		Max.Bundle Dia. mm	Min.Tensile Strength	
	mm	Inch		Lbs	kgs
BS-120KT	120	4.8"	25	18	8
BS-150KT	150	6"	35	18	8
BS-180KT	180	7"	45	18	8

### •应用场景 Application scenarios





## 不锈钢嵌片式扎带

### Nylon Metal Barb Tie

Material: 材质:	Nylon66(UL) 尼龙 66
Material-Metal Barb: 嵌片材质:	Stainless Steel Grade 304 or 316 不锈钢 316 或 304
Flame Class: 防火等级:	94V-2
Working Temperature: 适用温度范围:	-40°C ~85°C
Color: 颜色:	Nature or Black 本色或黑色



### •描述 Description

不锈钢金属齿锁结构

牢固的封闭设计，可在扎带带身上任何一处锁紧

带身上的点状结构可以防止捆绑后的横向滑动

高强度，操作简单方便

室内外皆可使用

Stainless steel metal tooth locking mechanism

Firm closure designed to lock at any point on the cable tie

Stippled strap body prevents lateral movement on the bundle

High strength and low thread force

Indoor and outdoor use

Item No.	Width	Length		Max. Bundle Dia.	Min. Tensile Strength	
	mm	mm	Inch	mm	Lbs	kgs
3x100	3	100	4"	22	18	8
4x150	4	150	6"	35	45	20
4x200	4	200	8"	53	45	20
5x250	5	250	10"	65	50	22
5x300	5	300	11.8"	76	50	22
6x200	6	200	8"	53	50	23
8x145	8	145	5.7"	34	120	55
8x175	8	175	7"	43	120	55
8x200	8	200	8"	53	120	55
8x240	8	240	9.5"	64	120	55
8x300	8	300	11.8"	76	120	55
8x400	8	400	15.8"	102	120	55
10x300	8	300	11.8"	76	135	60
10x350	10	350	13.8"	97	135	60
10x400	10	400	15.8"	102	135	60
10x450	10	450	17.7"	120	135	60
10x550	10	550	21.7"	141	135	60
10x600	10	600	23.6"	186	135	60



## 标牌式尼龙扎带

### Marker Cable Tie

Material: 材质:	Nylon66(UL) 尼龙 66
Flame Class: 防火等级:	94V-2
Working Temperature: 适用温度范围	-40°C ~85°C
Color: 颜色:	All colors are available 所有颜色均可定制



### •描述 Description

能同时简单的识别和固定电缆  
可在上面打印特制的标签  
可使用擦不掉的笔手工或临时标记

For simple identification and securing of cable bundles in one step  
Printable labels are available for a professional finish  
Manual or temporary marking is possible with an indelible pen

Item No.	Width		Length		Max.Bundle Dia.	Min.Tensile Strength		Sticker Size
	mm	mm	mm	inch		lbs	kgs	
BS-100MKT	2.5	100	4"	22	18	8	25X8	
BS-110MKT	2.5	110	4 1/3"	22	18	8	21X10	
BS-200MKT	2.5	200	8"	22	18	8	25X8	
BS-205MKT	3.6	205	8"	22	40	18	25X8	

### •应用场景 Application scenarios





## 固定头式扎带

### Mountable Head Ties

Material:	Nylon66(UL)
材质:	尼龙 66
Color:	All colors are available
颜色:	所有颜色均可定制



### •描述 Description

电线捆扎好后，用螺丝固定在板上。

After bundling wires, fix them on plate with screw.

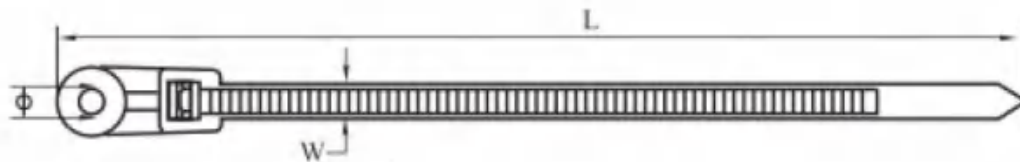

Item No.	Width		Length		Max.Bundle Dia.	Hole Dia.	Min.Tensile Strength	
	mm	mm	mm	Inch			Lbs	kgs
BS-3.6x100MT	3.6	100	4"	22	4.4	40	18	
BS-3.6x150MT	3.6	150	6"	35	4.4	40	18	
BS-3.6x200MT	3.6	200	8"	50	4.4	40	18	
BS-4.8x150MT	4.8	150	6"	35	5.2	50	22	
BS-4.8x200MT	4.8	200	8"	50	5.2	50	22	
BS-4.8x250MT	4.8	250	10"	65	5.2	50	22	
BS-4.8x300MT	4.8	300	11.8"	80	5.2	50	22	
BS-7.6x300MT	7.6	300	11.8"	80	6.2	120	55	
BS-7.6x400MT	7.6	400	15.7"	110	6.2	120	55	

## 双孔扎带

### Double Loop Cable Tie

Material: 材质:	Nylon66(UL) 尼龙 66
Color: 颜色:	All colors are available 所有颜色均可定制



### •描述 Description

双扎带是分离两段电缆的理想选择，无需额外的扎带。此外，这些扎带广泛应用于包装行业。第一个环锁紧袋子，而第二个环可以成为一个提携手柄（受重量）。

Double loop head ties are ideal for separation of two cable runs without the need for additional cable ties. Additionally these ties are widely used within the packaging industry. The first loop closes and secures the bag whilst the second loop can be made into a carrying handle (subject to weight).

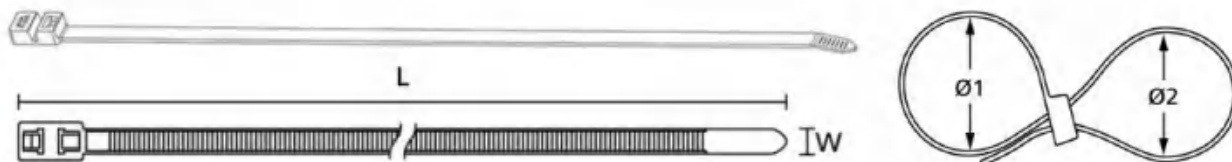

Item No.	Width		Length		Max.Bundle Dia. mm	Min.Tensile Strength	
	mm	mm	mm	Inch		Lbs	kgs
4.8x200DL	4.8	200	8"		50	50	22
4.8x225DL	4.8	225	9"		60	50	22
4.8x250DL	4.8	250	10"		65	50	22
4.8x300DL	4.8	300	11.8"		80	50	22
4.8x330DL	4.8	330	13"		88	50	22
4.8x370DL	4.8	370	14.6"		98	50	22
4.8x400DL	4.8	400	15.8"		110	50	22





## 手铐片式扎带

### Handcuff Tie

Material: 材质:	Nylon66(UL) 尼龙 66
Working Temperature: 适用温度范围:	-40°C ~85°C
Color: 颜色:	Nature or Black 本色或黑色



#### •描述 Description

手铐设计，可替代铁质手铐。

handcuff design, substitute for iron handcuff.

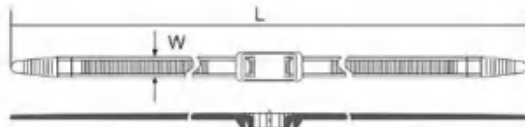

Item No.	Width		Length		Max.Bundle Dia.	Hole Dia.	Min.Tensile Strength	
	mm	mm	mm	Inch	mm	mm	Lbs	kgs
BS-700HST	12	700		25.6"	90		219	100

## 膨胀管式扎带

### Expand Plug Cable Tie

Material: 材质:	Nylon66(UL) 尼龙 66
Color: 颜色:	All colors are available 所有颜色均可定制



#### •描述 Description

用于将电缆线路、管道和其他构件固定在混凝土上。

For fixing cable routes, pipes and other elements to concrete.

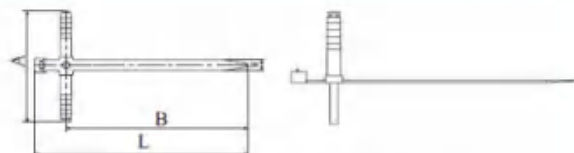

Item NO.	L		W	A	B	Max.Bundle Dia. E	Min.loop Tensile Strength	
	Inch	mm	mm	mm	mm	mm	LBS	KGS
BS-150EP	6"	150	7	79	128	35	85	38

## 塑料封条

### Plastic Seals

Material:	PP/PE
Specifications:	All plastic, easy for recycling
Applications:	All kinds of Containers, Trucks, Doors, Postal services, Courier services, Bags, etc.
Colors:	According to customers' requests.
	做一个颜色小圆圈: ● ● ● ● ● ● ● ●

#### •BS-301



Total Length:	295mm
Flag :	47mm x 26.5mm
Total Length:	225mm
Flag :	33mm x 18mm
Total Length:	340mm
Flag :	47mm x 26.5mm



#### •BS-302



Total Length:	340mm
Flag :	60mm x 20mm
Total Length:	465mm
Flag :	80mm x 40mm



#### •BS-303

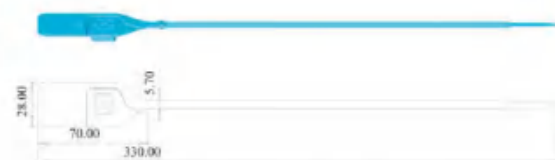

Total Length:	330mm
Flag :	70mm x 28mm
Total Length:	530mm
Flag :	45mm x 30mm



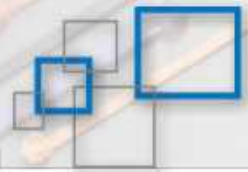

•BS-307

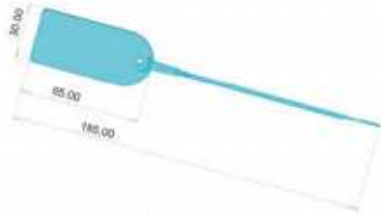

Total Length:	185mm
Flag :	65mm x 30mm



•BS-308



Total Length:	200mm
Flag :	60mm x 18mm



•BS-309



Total Length:	320mm
Flag :	47mm x 21mm
Total Length:	550mm
Flag :	58mm x 30mm



•BS-310



Total Length:	207.5mm
Flag :	170mm(L) x 8.2mm(W)



CABLE TIE SERIES



•BS-311



Total Length:	370mm
Flag :	45mm x 20mm



•BS-312

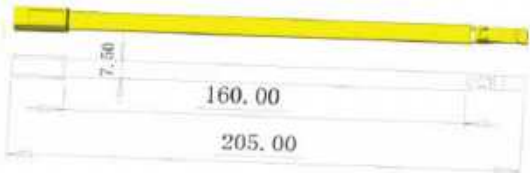

Total Length:	205mm
Flag :	160mm(L) x 7.5mm(W) x 1.35mm(Thickness)



•BS-314



Total Length:	400mm
Flag :	64mm x 22mm



•BS-316



Total Length:	330mm
Flag :	70mm x 28mm
Total Length:	530mm
Flag :	45mm x 30mm



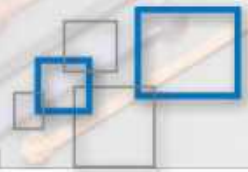

•BS-320



Total Length:	450mm
Flag :	105mm x 57mm



•BS-205F

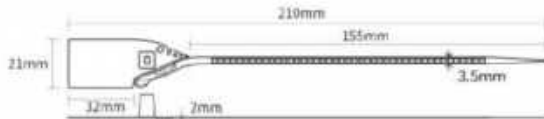

Total Length:	210mm
Flag :	32mm x 21mm



•BS-250D

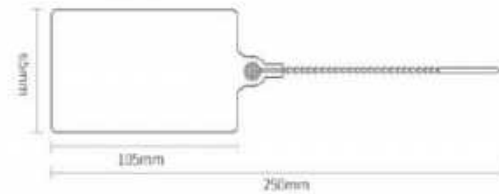

Total Length:	250mm
Flag :	105mm x 65mm



•BS-260



Total Length:	260mm
Flag :	59mm x 30mm



•BS-270

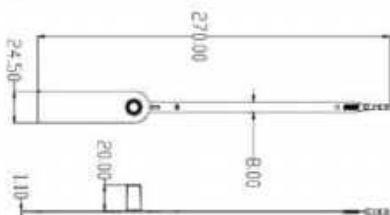

Total Length:	270mm
Flag :	85mm x 24mm



CABLE TIE SERIES

•BS-330

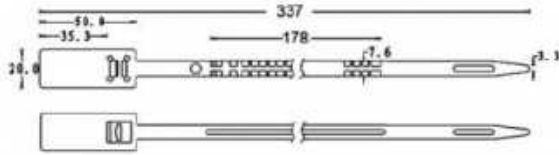

Total Length:	337mm
Flag :	50mm x 20mm



•BS-400F

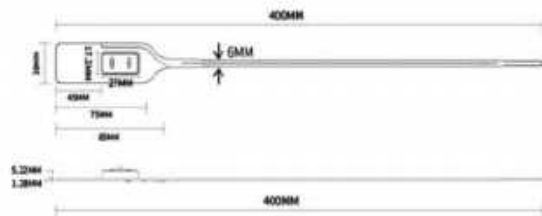

Total Length:	400mm
Flag :	85mm x 30mm



•BS-410S

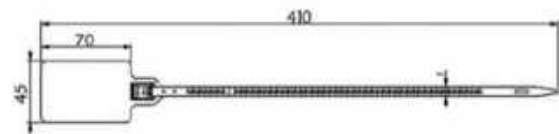

Total Length:	410mm
Flag :	92mm x 54mm



•BS-460

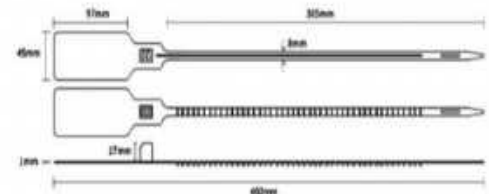

Total Length:	460mm
Flag :	97mm x 45mm







## 汽车防滑扎带

### Antiskid Ties

Material:	Nylon66(UL)
材质:	尼龙 66
Color:	All colors are available
颜色:	所有颜色均可定制



### •描述 Description

本系列汽车防滑链适用于雪地轮胎、防滑泥浆、防滑及结冰等场合。

使用特殊的防滑面，粗糙的表面增加了与道路的摩擦力，通常在雪地和泥泞的路况下，保护轮胎防止轮胎打滑，并保证车辆的正常行驶作用。

可以有效保证车辆的行驶水平，特别是在冬季雪地道路上，不仅仅是季节性的产品，在雨雪天气一样可以起到防滑的作用，而且在越野、山地行驶、野外探险等车辆行驶情况下也有着不可替代的作用。

These Anti-Skid Chains for Automobiles can be used in snow tires slippery mud slippery and icing situations.

The use of a special anti-skid surface rough surface that increases the friction with the road, usually in the snow and muddy road conditions, to protect the tire to prevent tire slip, and to ensure the normal driving role of the vehicle.

Can effectively guarantee the vehicle's driving level, especially in winter snow on the road, not just seasonal products, that is not only in winter and rain and snow weather can play a role in the same skiing, but cross-country, mountain driving, field exploration, and other Vehicle driving situation also has an irreplaceable role.

Item No.	Width		Length		Min. Tensile Strength		Max. Bundle Dia.
	mm	mm	mm	inch	lbs	kgs	mm
BS-10x920	10	920	36.2"		175	80	920

### •应用场景 Application scenarios



## 魔术贴扎带

### Magic Cable Tie

Material: 材质:	Hook Side:PP,Loop Side:Nylon 公面 PP, 母面: NYLON
Color: 颜色:	Black,White,Red,Yellow,Blue, Green 黑色、白色、红色、黄色、蓝色、 绿色



### •描述 Description

用途: 适用于网络线 (UTP\STP\FIBER)、讯号线、电源线的捆绑, 避免使用传统尼龙扎带时, 因过紧而影响传输速度。  
可重复使用。

Corder and cable management (UTP/STP/FIBER), wire harnesses, prevent interruption to transmission speed when using traditional Nylon cable ties.  
Reusable and easy to install.

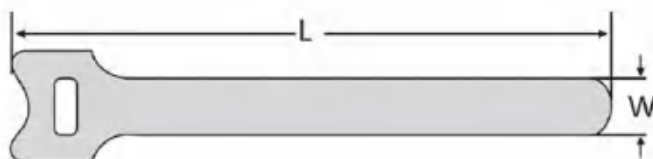

Item No.	Width	Length		Max.Bundle Dia.
	mm	mm	inch	mm
MGT-125	12	125	5"	30
MGT-135	12	135	5.3"	33
MGT-150	12	150	6"	35
MGT-180	12	180	7"	40
MGT-210	16	210	8.2"	50
MGT-240	16	240	9.4"	65
MGT-310	16	310	12.2"	85

### •应用场景 Application scenarios





# Car Cable Tie Series

汽车扎带系列





## 插销式扎带

### Push Mount Ties

Material: 材质:	Nylon66(UL) 尼龙 66
Flame Class: 防火等级:	94V-2
Working Temperature: 适用温度范围:	-40°C ~120°C
Color: 颜色:	Natural/Black 白色 / 黑色



### •描述 Description

具有各种各样的固定可能性，适用于许多不同的行业，包括汽车，航空航天和面板制造。

With a diverse range of fixing possibilities are ideal for use in many different industries, including automotive, aerospace and panel building.

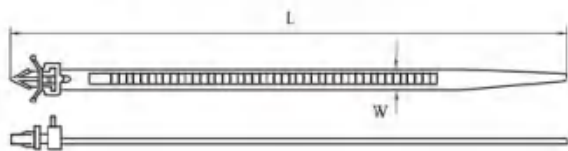

Item No.	Width		Length		Max.Bundle Dia. mm	Hole Dia. mm	Max.Bundle Dia. mm	Min.Tensile Strength	
	mm	mm	mm	inch				lbs	kgs
BS-7.2x150PT	7.2	150	6"		35	6.2-9.2	0.3-2.2	62	28
BS-8.0x220PT	8	220	6"		50	7.3-9.5	0.3-2.8	62	28

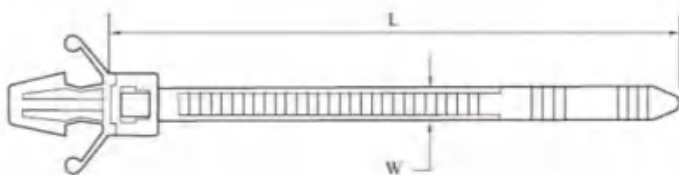

Item No.	Width		Length		Max.Bundle Dia. mm	Hole Dia. mm	Max.Bundle Dia. mm	Min.Tensile Strength	
	mm	mm	mm	inch				lbs	kgs
BS-2.5x100PT	2.5	100	4"		15	4.2-5.1	0.2-2	18	8
BS-3.6x150PT	3.6	150	6"		22	4.5-6	0.3-3	40	18
BS-3.6x200PT	3.6	200	8"		35	4.5-6	0.3-3	40	18
BS-4.8x120PT	4.8	120	4.8"		15	5.8-6.8	0.3-3	50	22
BS-4.8x150PT	4.8	150	6"		22	5.8-6.8	0.3-3	50	22
BS-4.8x200PT	4.8	200	8"		35	5.8-7	0.3-3	50	22



Item No.	Width		Length		Max.Bundle Dia.	Hole Dia.	Max.Bundle Dia.	Min.Tensile Strength	
	mm	mm	mm	inch	mm	mm	mm	lbs	kgs
BS-3.6x150PTF	3.6	150	6"		30	4.4-5.3	0.3-2.5	40	18
BS-4.8x200PTF	4.8	200	8"		35	6-7.3	0.3-2.5	50	22



Item No.	Width		Length		Max.Bundle Dia.	Hole Dia.	Max.Bundle Dia.	Min.Tensile Strength	
	mm	mm	mm	inch	mm	mm	mm	lbs	kgs
BS-6x170PTS	6	170	6.7"		40	5.1-6.5	0.3-3	55	24



No.01



No.01



No.02

No.	Item No.	Width		Length		Max.Bundle Dia.	Hole Dia.	Max.Bundle Dia.	Min.Tensile Strength	
		mm	mm	mm	inch	mm	mm	mm	lbs	kgs
01	BS-5x120	5	120	4.7"		16	6.6-7.3	0.3-3	50	22
	BS-5.2x165	5.2	165	6.5"		22	7.2-8.2	0.3-2	50	22
	BS-5.2x165	5.2	165	6.5"		22	6.3-7.0	2.3-3.5	55	24
02	7.2X150	7.2	150	6"		30	5.2-9.2	0.3-2.2	120	55

CABLE TIE SERIES



No.03



No.04



No.05

No.	Item No.	Width		Length		Max.Bundle Dia. mm	Hole Dia. mm	Max.Bundle Dia. mm	Min.Tensile Strength	
		mm	mm	mm	inch				lbs	kgs
03	4.6x160	4.6	160	6.3"	22	4.6x160	4.6	160	6.3"	
04	4.6x160	4.6	160	6.3"	22	6.9-7.3	0.3-1.9	50	22	
05	4.6x160	4.6	160	6.3"	22	5.4-6.4	0.3-1.8	50	22	



No.06



No.07



No.08

No.	Item No.	Width		Length		Max.Bundle Dia. mm	Hole Dia. mm	Max.Bundle Dia. mm	Min.Tensile Strength	
		mm	mm	mm	inch				lbs	kgs
06	4.6x160	4.6	160	6.3"	22	6.5-8	2-3	50	22	
07	5.2x165	5.2	165	6.5"	22	6.8-9.4	0.3-2.2	50	22	
08	6.5x165	6.5	165	6.5"	22	7.3-8.5	2-4	100	45	



No.09



No.10





No.	Item No.	Width		Length		Max.Bundle Dia.	Hole Dia.	Max.Bundle Dia.	Min.Tensile Strength	
		mm	mm	mm	inch				mm	mm
09	5.5x100	5.5	100	4"	15	6.5-7.2	0.5-8	62	28	
	5.5x150	5.5	150	6"	30	6.5-7.2	0.5-8	62	28	
	5.5x210	5.5	210	8.2"	45	6.5-7.2	0.5-8	62	28	
10	4.6x170	4.6	170	6.7"	45	6-6.5	0.5-8	50	22	



No.11



No.12



No.13

No.	Item No.	Width		Length		Max.Bundle Dia.	Hole Dia.	Max.Bundle Dia.	Min.Tensile Strength	
		mm	mm	mm	inch				mm	mm
11	4.6x160	4.6	160	6.3"	40	6-7	0.5-8	50	22	
12	4.6x220	4.6	220	8.6"	50	6.5-7.4	0.5-8	50	22	
13	4.6x165	4.6	165	6.5"	40	6.5-7.2	0.5-8	50	22	



No.14



No.15



No.16



No.17

No.	Item No.	Width		Length		Max.Bundle Dia.	Hole Dia.	Max.Bundle Dia.	Min.Tensile Strength	
		mm	mm	mm	inch				mm	mm
14	5.5x160	5.5	160	6.3"	40	7x12mm	0.3-3.2	62	28	
15	7x165	7	165	6.5"	40	7x12mm	0.3-3.2	113	50	
16	4.6x160	4.6	160	6.3"	40	5				
17	5.2x170	5.2	170	6.7"	45	5-6				

## 板材边缘卡扣固定扎带

### Edge Clip with Cable Tie

#### •描述 Description

Edge Clip Cable Ties allow fixture to a panel edge without the need to drill. The two-piece design allows the clip to be positioned anywhere along the length of the tie. Available in 8", 11", and 14" Lengths.

Integrated clip fits panels 1-3 mm (0.04"-0.12") thick.

Constructed from heat stabilized Nylon 6/6.

50 lb tensile strength.

Meets UL94V-2 flammability classification.

Operating Temperature: -40°C to 85°C (40°F to 185°F).

Max short term temperature: 110°C (230°F).



Item No.	Material	Color	For Panel Thickness	Bundle Diameter	Dimension			Original Code
			mm	mm	L	W	H	
156-00771 156-00870 156-00015	PA66/65Mn	Black	1-3	1.5-35	150	4.6	1.3	T50SOSEC10
156-00598 156-00869	PA66/65Mn	Black	1-3	1.5-35	150	3.6	1.2	T30REC10
156-00621 156-00871 156-05904 156-01305	PA66/65Mn	Black	1-3	1.5-45	200	4.6	1.3	T50ROSEC10 T50ROSEC10SD
156-00552 156-00383 156-01039	PA66/65Mn	Black	1-3	1.5-45	200	4.7	1.3	T50REC10
156-00297 156-01438 156-00461 150-76099 156-00860	PA66/65Mn	Black	1-3	4-45	200	4.6	1.3	T50ROSEC4A
156-00642 150-76093 156-00858 156-01440	PA66/65Mn	Black	1-3	4-35	150	4.6	1.3	T50SOSEC4A
156-00615 156-00539 150-76091 156-01114	PA66/65Mn	Black	1-3	4-45	150	3.6	1.2	T50REC4A



Item No.	Material	Color	For Panel Thickness	Bundle Diameter	Dimension			Original Code
			mm	mm	L	W	H	
156-00898 156-00384 156-00555	PA66/65Mn	Black	3-6	1-45	200	4.7	1.3	T50REC20
156-00527 156-00799	PA66/65Mn	Black	3-6	1-35	150	3.6	1.2	T30REC20
156-00830 156-00016	PA66/65Mn	Black	3-6	1-35	150	4.6	1.3	T50SOSEC20
156-00674 156-00834 156-00873 156-00020	PA66/65Mn	Black	3-6	1-45	200	4.6	1.3	T50ROSEC20



Item No.	Material	Color	For Panel Thickness	Bundle Diameter	Dimension			Original Code
			mm	mm	L	W	H	
156-00579 156-01255 156-00963 156-00244	PA66/65Mn	Black	1-3	1-20	100	2.45	1	T18REC9SD T18REC9SDSET
156-00573	PA66/65Mn	Black	1-3	1-35	150	3.6	1.2	T30REC9SD
156-01140/ 156-00019/ 156-00866	PA66/65Mn	Black	1-3	1-35	150	4.6	1.3	T50SOSEC9SD
156-00385 156-01280 156-00913 156-00551	PA66/65Mn	Black	1-3	1-45	200	4.7	1.3	T50REC9 T50REC9SD
156-00583 156-00867 156-05903	PA66/65Mn	Black	1-3	1-45	200	4.6	1.3	T50ROSEC9SD
156-00546 156-01182 156-00462 156-00861 150-76079	PA66/65Mn	Black	1-3	4-45	200	4.6	1.3	T50ROSEC4B

CABLE TIE SERIES



Item No.	Material	Color	For Panel Thickness	Bundle Diameter	Dimension			Original Code
			mm	mm	L	W	H	
156-00643 156-01441 150-76083 156-00859 156-00109	PA66/65Mn	Black	1-3	4-35	150	4.6	1.3	T50SOSEC4B
156-00947 156-02979	PA66/65Mn	Black	3-6	1.5-35	150	3.6	1.2	T30REC19
156-01355 156-01309 156-04601	PA66/65Mn	Black	3-6	1.5-35	150	4.6	1.3	T50SOSEC19
156-00673 156-00872 156-01038 156-04602	PA66/65Mn	Black	3-6	1.5-45	200	4.6	1.3	T50ROSEC19
156-00897 156-00907 156-00537	PA66/65Mn	Black	3-6	1.5-45	200	4.7	1.3	T50REC19
156-00646 156-00774 156-00396 156-00877 156-00006	PA66/65Mn	Black	3-6	1-45	200	4.6	1.3	T50ROSEC23
156-00548 150-76080 156-00856 156-00893	PA66/65Mn	Black	1-3	4-35	150	3.6	1.2	T30REC4B
156-00616 156-00538 156-00940	PA66/65Mn	Black	1-3	4-45	200	4.7	1.3	T50REC4B
156-01254 T18REC22 156-00971 156-00180	PA66/65Mn	Black	1-3	1-20	100	2.45	1	T18REC22SET
156-00915	PA66/65Mn	Black	1-3	1-35	150	3.6	1.2	T30REC22
156-00669 156-00011	PA66/65Mn	Black	1-3	1-45	200	4.6	1.3	T50ROSEC22
156-00875	PA66/65Mn	Black	1-3	1-35	150	4.6	1.3	T50SOSEC22
156-00576 156-01010	PA66/65Mn	Black	1-3	1-45	200	4.7	1.3	T50REC22
156-00672 156-01117 156-00775 156-00398 156-00878 156-00007	PA66/65Mn	Black	3-6	1-45	200	4.7	1.3	T50ROSEC24



Item No.	Material	Color	For Panel Thickness	Bundle Diameter	Dimension			Original Code
			mm	mm	L	W	H	
156-01254 T18REC22 156-00971 156-00180	PA66/65Mn	Black	1-3	1-20	100	2.45	1	T18REC22SET
156-00915	PA66/65Mn	Black	1-3	1-35	150	3.6	1.2	T30REC22
156-00669 156-00011	PA66/65Mn	Black	1-3	1-45	200	4.6	1.3	T50ROSEC22
156-00875	PA66/65Mn	Black	1-3	1-35	150	4.6	1.3	T50SOSEC22
156-00576 156-01010	PA66/65Mn	Black	1-3	1-45	200	4.7	1.3	T50REC22
156-00672 156-01117 156-00775 156-00398 156-00878 156-00007	PA66/65Mn	Black	3-6	1-45	200	4.7	1.3	T50ROSEC24



Item No.	Material	Color	For Panel Thickness	Bundle Diameter	Dimension			Original Code
			mm	mm	L	W	H	
156-00495	PA66/65Mn	Black	1-3	4-35	150	3.6	1.2	T30REC5A
156-00644 156-00865 156-00788 156-01434 150-40593 T50SOSEC5A	PA66/65Mn	Black	1-3	4-35	150	4.6	1.3	T50SOSEC5A
156-00617 156-00541 156-01037 156-01437	PA66/65Mn	Black	1-3	4-45	200	4.7	1.3	T50REC5A
156-00622 150-40591	PA66/65Mn	Black	1-3	4-45	200	4.6	1.3	T50ROSEC5A

CABLE TIE SERIES

Item No.	Material	Color	For Panel Thickness	Bundle Diameter	Dimension			Original Code
			mm	mm	L	W	H	
156-00529	PA66/65Mn	Black	1-3	4-35	150	3.6	1.2	T30REC5B
156-00896 156-00540	PA66/65Mn	Black	1-3	4-45	200	4.7	1.3	T50REC5B
156-00684 156-00863 156-00789 156-01435	PA66/65Mn	Black	1-3	4-35	150	4.6	1.3	T50SOSEC5B
156-00623 156-00862 156-00464 156-01433	PA66/65Mn	Black	1-3	4-45	200	4.6	1.3	T50ROSEC5B
156-01258 156-01288 156-00179 156-00991	PA66/65Mn	Black	1-3	1-18		2.45		T18REC21 T18REC21SET
156-00575 156-00010	PA66/65Mn	Black	1-3	1-45	200	4.6	1.3	T50ROSEC21
156-00628 156-00017	PA66/65Mn	Black	1-3	1-35	150	4.6	1.3	T50SOSEC21
156-01095 156-00553 156-00387	PA66/65Mn	Black	1-3	1-45	200	4.7	1.3	T50REC21
156-00568	PA66/65Mn	Black	1-3	1-35	150	3.6	1.2	T30REC21



Item No.	Material	Color	For Panel Thickness	Bundle Diameter	Dimension			Original Code
			mm	mm	L	W	H	
156-01026	PA66/65Mn	Black	3-6	1-35	150	3.6	1.2	T30REC23
156-00908 156-00556 156-02459	PA66/65Mn	Black	3-6	1-45	200	4.7	1.3	T50REC23
156-00909	PA66/65Mn	Black	3-6	1-45	200	4.7	1.3	T50REC24





## 不锈钢扎带

### Stainless Steel Cable Ties

Material: 材质:	Stainless Steel Grade 201, 304 or 316 不锈钢 201、316 或 304
Flame Class: 防火等级:	Fireproof 阻燃
Working Temperature: 适用温度范围:	-80°C—538°C
Description: 产品描述:	Entirely metallic 金属色带及搭扣



### •特性 Speciality

抗紫外线

滚珠设计有利于加快安装速度

UV-resistant

Ball-lock type will speed up the installation

### •应用领域 Application

造船业、港口、机械、汽车、航空、电力、通信、核能、城际机车等行业

Shipbuilding, port, machinery, automobiles, aviation, electricity, communication, electronics, nuclear power, interurban locomotive and other industries

Item No.	Width		Length		Thickness		Max. Bundle Dia.		Min. Tensile Dia.		Min. Tensile Strength"	
	mm	mm	mm	inch	mm	inch	mm	inch	mm	inch	N	lbs
SS4.6x100	4.6	100	3.9 "	0.25	0.01 "	36	1 "	12.7	0.5 "	1100	250	
SS4.6x150		150	5.9 "			37	1.46 "					
SS4.6x200		200	7.9 "			50	1.97 "					
SS4.6x250		250	9.8 "			63	2.5 "					
SS4.6x300		300	11.8 "			76	3 "					
SS4.6x350		350	13.8 "			89	3.51 "					
SS4.6x400		400	15.7 "			102	4 "					
SS4.6x450		450	17.7 "			115	4.5 "					
SS4.6x500		500	19.7 "			128	5 "					
SS4.6x550		550	21.7 "			141	5.56 "					
SS4.6x650		650	25.6 "			167	6.58 "					
SS4.6x700		700	27.6 "			179	7.05 "					
SS4.6x800		800	31.5 "			193	7.6 "					
SS4.6x900		900	35.4 "			200	7.87 "					
SS4.6x1000		1000	39.4 "			206	8.12 "					
SS4.6x1100	1100	43.3 "	278	10.94 "								

Item No.	Width		Length		Thickness		Max.Bundle Dia.		Min.Tensile Dia.		Min.Tensile Strength"	
	mm	mm	inch	mm	inch	mm	inch	mm	inch	N	lbs	
SS7.9x150	7.9	150	5.9 "	0.35	0.014 "	37	1.46 "	12.7	0.5 "	1200	270	
SS7.9x200		200	7.9 "			50	1.97 "					
SS7.9x250		250	9.8 "			63	2.5 "					
SS7.9x300		300	11.8 "			76	3 "					
SS7.9x350		350	13.8 "			89	3.5 "					
SS7.9x400		400	15.7 "			102	4 "					
SS7.9x500		500	19.7 "			128	5 "					
SS7.9x600		600	23.6 "			154	6.07 "					
SS7.9x800		800	31.5 "			193	7.6 "					
SS7.9x1000		1000	39.4 "			206	8.12 "					
SS10x300	10	300	11.8 "	0.3	0.012 "	76	3 "	12.7	0.5 "	1700	390	
SS10x350		350	13.8 "			89	3.5 "					
SS10x400		400	15.7 "			102	4 "					
SS10x500		500	19.7 "			128	5 "					
SS10x600		600	23.6 "			154	6.07 "					
SS10x800		800	31.5 "			193	7.6 "					
SS10x1000		1000	39.4 "			206	8.12 "					
SS12x350	12	350	13.8 "	0.30-0.35	0.012-0.014	78	3.07 "	25.4	1 "	2200	500	
SS12x400		400	15.7 "			102	4.02 "					
SS12x500		500	19.7 "			128	5.04 "					
SS12x600		600	23.6 "			154	6.06 "					
SS12x750		750	29.5 "			188	7.4 "					
SS12x900		900	35.4 "			228	8.98 "					
SS12x1100		1100	43.3 "			278	10.94 "					

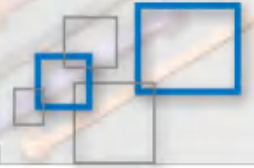

Item No.	Width		Length		Thickness		Max.Bundle Dia.		Min.Tensile Dia.		Min.Tensile Strength"	
	mm	mm	inch	mm	inch	mm	inch	mm	inch	N	lbs	
SS16x350	16	350	13.8 "	0.30-0.35	0.012-0.014	78	3.07 "	25.4	1 "	3400	770	
SS16x400		400	15.7 "			102	4.02 "					
SS16x450		450	17.7 "			108	4.25 "					
SS16x600		600	23.6 "			148	5.83 "					
SS16x750		750	29.5 "			184	7.24 "					
SS16x900		900	35.4 "			220	8.66 "					
SS16x1100		1100	43.3 "			272	10.71 "					

•应用场景 Application scenarios



CABLE TIE SERIES



## 不锈钢粘塑带

### Stainless Steel PVC Coated Ties

Material: 材质:	Stainless Steel Grade 304 or 316 不锈钢 316 或 304
Coating: 喷塑材料:	PVC
Flame Class: 防火等级:	Fireproof 阻燃
Working Temperature: 适用温度范围:	-40°C ~85°C
Description: 产品描述:	Black Band with Metallic Buckle 黑色带身及金属色搭扣



### •特性 Speciality

抗紫外线

金属搭扣有利于区别黑色尼龙扎带

PVC 包塑带身更厚, 更柔软

喷塑带身能避免金属件的腐蚀

UV-resistant

Metallic buckle helps to distinguish from black nylon cable ties

PVC coated band is thicker and softer

Coated band can prevent the corrosion between dissimilar materials.

### •应用领域 Application

造船业、港口、机械、汽车、航空、电力、通信、核能、城际机车等行业

Shipbuilding, port, machinery, automobiles, aviation, electricity, communication, electronics, nuclear power, interurban locomotive and other industries

Item No.	Width		Length		Thickness		Max. Bundle Dia.		Min. Tensile Dia.		Min. Tensile Strength	
	mm	mm	inch	mm	inch	mm	inch	mm	inch	N	lbs	
SSP5.6x150	5.6	150	5.9 "	0.8	0.039 "	37	1.46 "	12.7	0.5 "	400	90	
SSP5.6x200		200	7.9 "			50	1.97 "					
SSP5.6x250		250	9.8 "			63	2.48 "					
SSP5.6x350		350	13.8 "			89	3.5 "					
SSP5.6X450		450	17.7 "			115	4.53 "					
SSP5.6X600		600	23.6 "			154	6.06 "					
SSP5.6X750		750	29.5 "			178	7.01 "					
SSP5.6X900		900	35.4 "			229	9.02 "					
SSP9X200	9	200	7.9 "	0.9	0.039 "	52	2.05 "	25.4	1 "	600	135	
SSP9X250		250	9.8 "			65	2.56 "					
SSP9X300		300	11.8 "			78	3.07 "					
SSP9X400		400	15.7 "			102	4.02 "					
SSP9X450		450	17.7 "			118	4.08 "					
SSP9X500		500	19.7 "			128	5.04 "					
SSP9X650		650	25.6 "			165	6.5 "					
SSP9X800		800	31.5 "			204	8.03 "					
SSP9X1000		1000	39.4 "			254	10 "					



## 不锈钢喷塑扎带

### Stainless Steel Epoxy Coated Ties

Material: 材质:	Stainless Steel Grade 304 or 316 不锈钢 316 或 304
Coating: 喷塑材料:	Polyester/Epoxy, Nylon11 环氧聚酯粉末, 尼龙 11
Flame Class: 防火等级:	Fireproof 阻燃
Working Temperature: 适用温度范围:	-80°C ~150°C
Description: 产品描述:	Black Band with Metallic Buckle 黑色带身及金属色搭扣



### •特性 Speciality

抗紫外线, 无卤无毒;  
全喷塑可防止静电;  
喷塑带身能避免金属件的腐蚀;

UV-resistant, Halogen free, non toxic .  
Fully coated version can prevent from static electricity.  
Coated band can prevent the corrosion between dissimilar materials.

### •应用领域 Application

造船业、港口、机械、汽车、航空、电力、通信、核能、城际机车等行业

Shipbuilding, port, machinery, automobiles, aviation, electricity, communication selectronics, nuclear power, interurb an locomotive and other industries

Item No.	Width		Length		Thickness		Max.Bundle Dia.		Min.Tensile Dia.		Min.Tensile Strength"	
	mm	mm	mm	inch	mm	inch	mm	inch	mm	inch	N	lbs
SSC4.6x100	4.6	100	3.9 "	0.35	0.014 "	25	1 "	12.7	0.5 "	900	200	
SSC4.6x150		150	5.9 "			37	1.46 "					
SSC4.6x200		200	7.9 "			50	1.97 "					
SSC4.6x250		250	9.8 "			63	2.5 "					
SSC4.6x300		300	11.8 "			76	3 "					
SSC4.6x350		350	13.8 "			89	3.51 "					
SSC4.6x400		400	15.7 "			102	4 "					
SSC4.6x450		450	17.7 "			115	4.5 "					
SSC4.6x500		500	19.7 "			128	5 "					
SSC4.6x550		550	21.7 "			141	5.56 "					
SSC4.6x650		650	25.6 "			167	6.58 "					
SSC4.6x700		700	27.6 "			179	7.05 "					
SSC4.6x800		800	31.5 "			193	7.6 "					
SSC4.6x900		900	35.4 "			200	7.87 "					
SSC4.6x1000	1000	39.4 "	206	8.12 "								
SSC4.6x1100	1100	43.3 "	278	10.94 "								

Item No.	Width		Length		Thickness		Max.Bundle Dia.		Min.Tensile Dia.		Min.Tensile Strength"	
	mm	mm	inch	mm	inch	mm	inch	mm	inch	N	lbs	
SSC7.9x150	SS8	150	5.9 "	0.25	0.01 "	37	1.46 "	12.7	0.5 "	1500	340	
SSC7.9x200		200	7.9 "			50	1.97 "					
SSC7.9x250		250	9.8 "			63	2.5 "					
SSC7.9x300		300	11.8 "			76	3 "					
SSC7.9x350		350	13.8 "			89	3.5 "					
SSC7.9x400		400	15.7 "			102	4 "					
SSC7.9x500		500	19.7 "			128	5 "					
SSC7.9x600		600	23.6 "			154	6.07 "					
SSC7.9x800		800	31.5 "			193	7.6 "					
SSC7.9x1000		1000	39.4 "			206	8.12 "					
SSC10x300	10	300	11.8 "	0.3	0.012 "	76	3 "	12.7	0.5 "	2100	480	
SSC10x350		350	13.8 "			89	3.5 "					
SSC10x400		400	15.7 "			102	4.00 "					
SSC10x500		500	19.7 "			128	5 "					
SSC10x600		600	23.6 "			154	6.07 "					
SSC10x800		800	31.5 "			193	7.6 "					
SSC10x1000		1000	39.4 "			206	8.12 "					
SSC12x350	12	350	13.8 "	0.30-0.35	0.012-0.014	78	3.07 "	25.4	1 "	3000	675	
SSC12x400		400	15.7 "			102	4.02 "					
SSC12x500		500	19.7 "			128	5.04 "					
SSC12x600		600	23.6 "			154	6.06 "					
SSC12x750		750	29.5 "			188	7.4 "					
SSC12x900		900	35.4 "			228	8.98 "					
SSC12x1100		1100	43.3 "			278	10.94 "					





Item No.	Width		Length		Thickness		Max.Bundle Dia.		Min.Tensile Dia.		Min.Tensile Strength"	
	mm	mm	inch	mm	inch	mm	inch	mm	inch	N	lbs	
SSC16x350	16	350	13.8 "	0.30-0.35	0.012-0.014	78	3.07 "	25.4	1 "	4000	900	
SSC16x400		400	15.7 "			102	4.02 "					
SSC16x450		450	17.7 "			108	4.25 "					
SSC16x600		600	23.6 "			148	5.83 "					
SSC16x750		750	29.5 "			184	7.24 "					
SSC16x900		900	35.4 "			220	8.66 "					
SSC16x1100		1100	43.3 "			272	10.71 "					

## 鱼骨扎带

### Fish Bone Shape Head Ties

Material: 材质:	PE
Working Temperature: 适用温度范围:	-40℃ ~85℃
Color: 颜色:	Natural,black,UV black,other colors are available as requested. 本色、黑色、抗紫外线之黑色。特殊颜色均可定做。

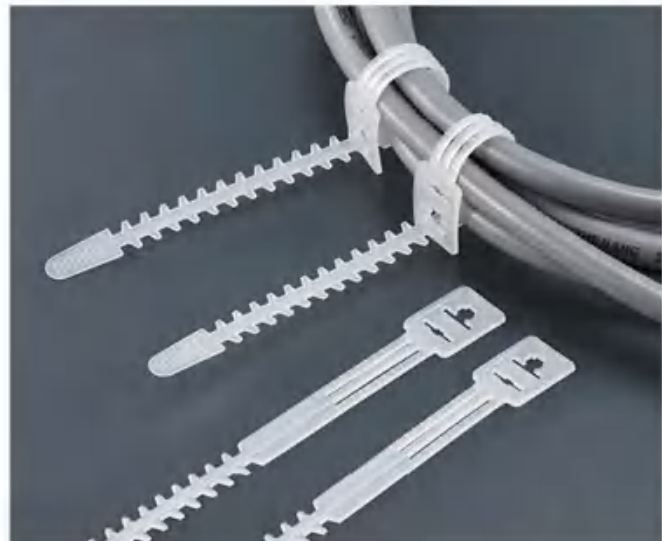

Item No.	Size (W * L)	捆扎范围 (mm)	拉力	
	W x L	E	LBS	KGS
BS-Y115	9x115	25	9	4
BS-Y135	9x135	30	9	4
BS-Y140	9x140	32	9	4
BS-Y155	9x155	38	9	4
BS-Y160	9x160	40	9	4
BS-Y200	9x200	50	9	4
BS-Y210	9x210	53	9	4

CABLE TIE SERIES

# Cable Clip Series

线卡系列





## 圆型钢钉线卡

### Circle Cable Clip

Material:	PE, Steel nail
材质:	PE 材质制成, 附钢钉

#### •用法 How to use

将电线置于塑料线卡内, 用铁锤将钢钉钉上墙壁即可固定电线。

Put the cable under the clip and hammer the nail into the wall to secure the cable .

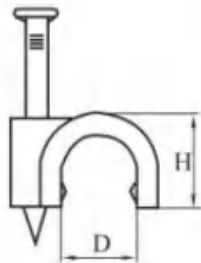

Item No.	High	D	Nail	Packing
	mm	mm	mm	
4MM	5.3	4.0	1.7x15	100pcs
5MM	6.3	5.0	1.7x15	
6MM	7.4	6.0	1.8x16	
7MM	8.4	7.0	1.8x18	
8MM	9.4	8.0	1.9x18	
9MM	10.4	9.0	2.0x20	
10MM	11.4	10.0	2.0x22	
12MM	13.4	12.0	2.0x25	
14MM	16.4	14.0	2.3x38	
16MM	17.7	16.0	2.3x32	
18MM	19.7	18.0	2.5x35	
20MM	22.2	20.0	2.8x38	
22MM	25.0	22.0	2.8x40	
25MM	27.7	25.0	3.0x45	
30MM(Double Nail)	33.1	30.0	3.5x55	
32MM(Double Nail)	35.6	32.0	3.5x55	
35MM(Double Nail)	36.6	35.0	3.5x60	
40MM(Double Nail)	45.2	40.0	3.6x65	
50MM(Double Nail)	53.2	50.0	3.5x65	



## K 型钢钉线卡

### K-type Circle Cable Clip

Material:	PE,Steel nail
材质:	PE 材质制成, 附钢钉

#### •用法 How to use

将电线置于塑料线卡内, 用铁锤将钢钉钉上墙壁即可固定电线。

Put the cable under the clip and hammer the nail into the wall to secure the cable .

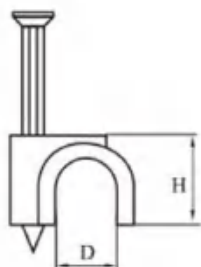
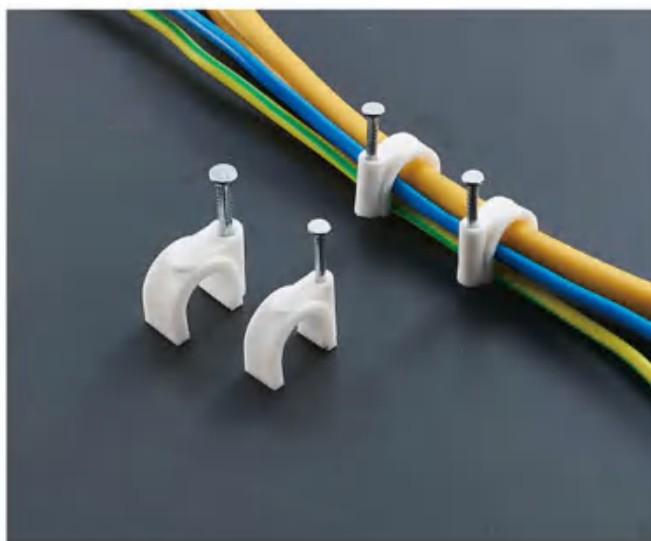

Item No.	High	D	Nail	Packing
	mm	mm	mm	
K-4MM	6.3	4.0	2.5x18	100pcs
K-5MM	7.4	5.0	2.5x18	
K-6MM	8.4	6.0	2.5x20	
K-7MM	9.7	7.0	2.5x20	
K-8MM	13.0	8.0	2.5x22	
K-9MM	13.0	9.0	2.5x22	
K-10MM	13.8	10.0	2.5x25	
K-12MM	16.0	12.0	2.5x27	
K-14MM	18.5	14.0	2.5x27	
K-16MM	21.0	16.0	3.0x37	
K-22MM	26.0	22.0	3.0x41	
K-25MM	31.0	25.0	3.0x47	

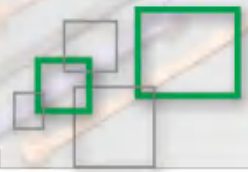

## 扁型钢钉线卡

### Flat Cable Clip

Material:	PE, Steel nail
材质:	PE 材质制成, 附钢钉

#### •用法 How to use

将电线置于塑料线卡内, 用铁锤将钢钉钉上墙壁即可固定电线。

Put the cable under the clip and hammer the nail into the wall to secure the cable .

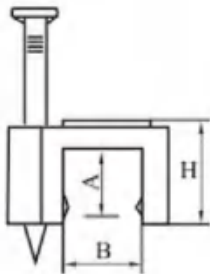
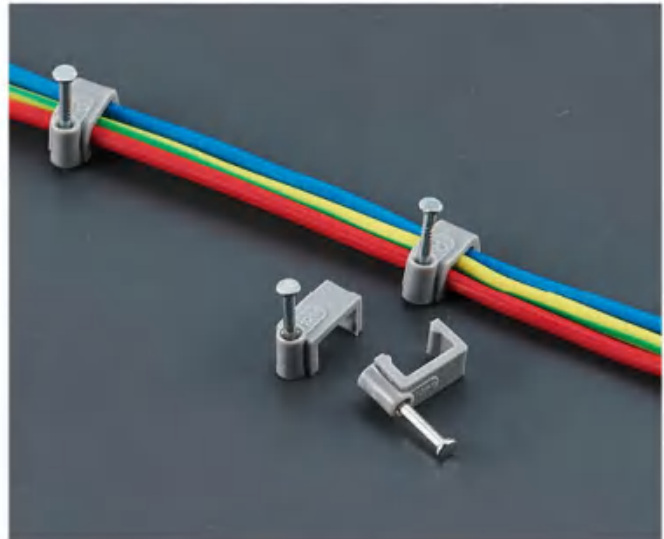

Item No.	H	A	B	Nail	Packing
	mm	mm	mm		
F-4MM	6.0	3.8	4	1.7x15	100pcs
F-5MM	6.0	3.8	5	1.7x15	
F-6MM	6.5	4.1	6	1.7x15	
F-7MM	7.0	4.7	7	1.8x16	
F-8MM	7.5	5.0	8	1.8x16	
F-9MM	8.2	5.4	9	1.8x16	
F-10MM	8.6	5.7	10	1.8x18	
F-12MM	9.0	6.1	12	2.0x20	
F-14MM	11.0	8.0	14	2.0x20	

## 钩型钢钉线卡

### Hook Cable Clip

Material:	PE, Steel nail
材质:	PE 材质制成, 附钢钉

#### •用法 How to use

将电线置于塑料线卡内, 用铁锤将钢钉钉上墙壁即可固定电线。

Put the cable under the clip and hammer the nail into the wall to secure the cable .



Item No.	A	Nail	Packing
	mm		
0507	5-7	1.2x20	100pcs
0710	7-10	1.7x25	
0812	8-12	2.0x25	
1014	10-14	2.0x30	
1115	11-15	2.8x42	
1619	16-19	2.6x38	
1419	14-19	2.6x38	
1620	16-20	2.8x50	

#### •Cable clips value park







## 金属阻燃线卡

### Metal Fire Resistant Cable Clips

Material: 材质:	Carbon steel/stainless steel 碳钢
Color: 颜色:	Red、White、Black 红色、白色、黑色
Operating Temperature: 特点:	0-930°C

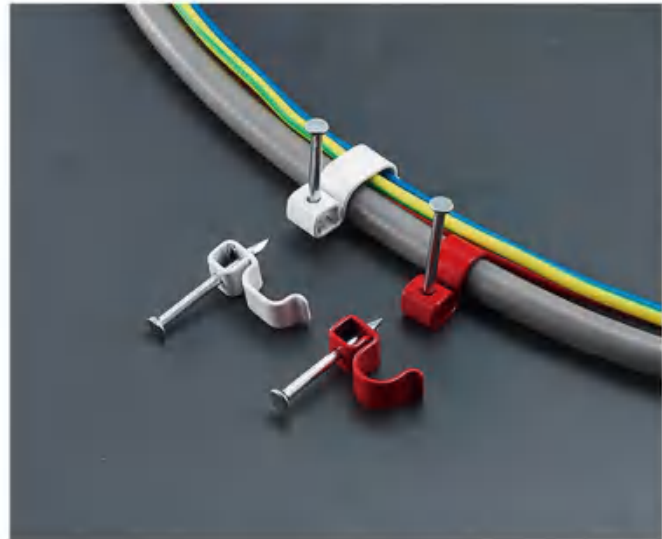

### •特点 Advantage

具有防火性能

快速固定性能

在火灾 930 摄氏度温度中可承受 60 分钟

火灾中不易过早倒塌

Firefly flat metal nail-in fixing cleats for 18th edition cable installation with fire resistant properties. Fast fix performance cleats that can withstand temperatures and fires up to 930 degrees C for up to 60 minutes, and not prone to premature collapse.

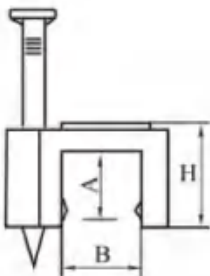

Item No.	A	B	Nail	Packing
	mm	mm		
M-8MM	7.5	6	2.25x29	100pcs
M-9MM	9.0	6.5	2.25x29	
M-10MM	10.0	8	2.25x29	
M-14MM	13.0	8	2.25x29	

### •Cable clips value park



## 羊角管夹

### Plastic Pipe Clamp

Material:	PE
材质:	采用 PE 材质制成

#### •特点 Advantage

升级 PE 塑料管夹，一体式成型，安装在瓷砖墙面上不易开裂，美观方便，省力安装大大提高了安装人员的工作效率。

适用于各种管道（水管、管线）外露 / 隐蔽安装。



Upgraded PE plastic pipe clamp, one-piece molding, not easy to crack when installed on the ceramic tile wall, beautiful and convenient, labor-saving installation greatly improves the work efficiency of workers. Suitable for all kinds of pipes (water pipes, line pipes) exposed/concealed installation.

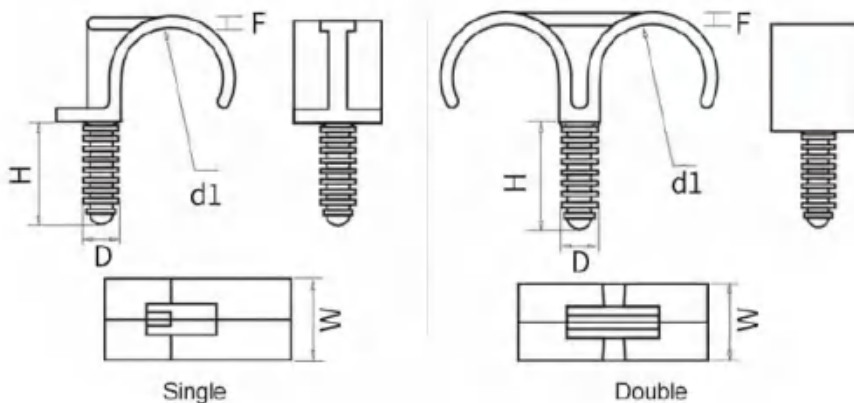

tem No.	Dimensions(mm)					Tube
	H	D	d1	w	F	
20 Single	30	10	20	19.2	2.55	20mm
25 Single	30	10	25	19.2	2.6	25mm
20 Double	30	10	20	19.2	2.55	20mm
25 Double	30	10	25	19.2	2.6	25mm

# Cable Gland Series

电缆接头系列





## 电缆接头

### Nylon Cable Gland



螺帽



主体



防水圈



迫紧螺帽

Thread:	Metric, PG
Material:	UL approved Nylon PA66(Flammability UL94V-2)for A.C.F parts;(Accpet to make flammability UL V-0); EPDM rubber for B.D parts(Accpet to make super rubber:resist high temperature rubber ,resist strong acid/alkali,etc)
Protection degree:	IP68-10
Working temperature:	-40 °C to 100°C
Features:	The claws and seals of excellent design,sealing nut have a "click"sound and re-open,can hold cable firmly and have a wider cable range.Resistant to salt water,weak acid,alcohol,oil,grease and common solvency.

Item No.	Cable Range Φ(mm)		Thread O.D.	Thread Length	Spanner Size	Std.Pkg
	常规型	加厚型	L2(mm)	L1(mm)	A&F(mm)	(pcs)
PG7	3-6.5	2-5	12.5	9	18/16	100/6000
PG9	4-8	2-6	15.2	9	22/19	100/4000
PG11	5-10	3-7	18.6	9	24/22	100/2500
PG13.5	6-11	5-9	20.4	10	27/24	100/2000
PG16	10-13	7-12	22.5	10	30/27	100/1700
PG19	12-15	10-12	24	10	30/28	100/1600
PG21	13-18	9-16	28.3	12	35/33	100/1000
PG25	16-21	13-18	30	12	37/35	100/800
PG29	18-25	13-20	37	12	45/42	50/500
PG36	22-32	20-26	47	15	57/52	20/360
PG42	32-38	25-31	54	18	62/58	20/220
PG48	37-44	29-35	59.3	18	70/64	20/240
PG63	42-50	32-40	71	30	83/77	10/100



Item No.	Cable Range Φ(mm)		Thread O.D.	Thread Length	Spanner Size	Std.Pkg
	常规型	加厚型	L2(mm)	L1(mm)	A&F(mm)	(pcs)
M12x1.5	3-6.5	2-5	12	9	18/16	100/6000
M16x1.5	4-8	2-6	16	9	22/19	100/4000
M18x1.5	5-10	3-7	18	9	24/22	100/2500
M20x1.5	6-11	5-9	20	10	27/24	100/2000
M22x1.5	10-13	7-12	22	10	30/27	100/1700
M24x1.5	12-15	10-12	24	10	30/28	100/1600
M25x1.5	12-15	10-12	25	11	31/28	100/1000
M27x1.5	13-18	9-16	27	12	35/33	100/1000
M30x1.5	16-21	13-18	30	12	37/35	100/800
M32x1.5	16-21	13-18	32	12	38/35	100/800
M36x1.5	18-25	13-20	36	12	45/42	50/500
M40x1.5	22-32	20-26	40	15	52/50	20/360
M50x1.5	32-38	25-31	50	18	62/58	20/220
M63x1.5	37-44	29-35	63	18	72/64	20/240
M71x1.5	42-50	32-40	71	29	83/77	
M80x2	55-62		80	21	90	
M88x2	56-66		88	21	100	
M90x2	66-77		90	21	100	

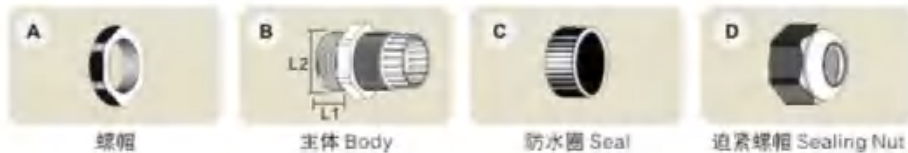

Item No.	Cable Range Φ(mm)		Thread O.D.	Thread Length	Spanner Size
	常规型	加厚型	L2(mm)	L1(mm)	A&F(mm)
PG7-L	3-6.5	2-5	12.5	15	18/16
PG9-L	4-8	2-6	15.2	15	22/19
PG11-L	5-10	3-7	18.6	15	24/22
PG13.5-L	6-11	5-9	20.4	15	27/24
PG16-L	10-13	7-12	22.5	15	30/27
PG19-L	12-15	10-12	24.0	15	30/28
PG21-L	13-18	9-16	28.3	15	35/33
PG25-L	16-21	13-18	30	15	37/35
PG29-L	18-25	13-20	37	15	45/42
PG36-L	22-32	20-26	47	15	58/52
PG42-L	32-38	25-31	54	18	62/58
PG48-L	37-44	29-35	60	20	70/64

CABLE GLAND SERIES

## 金属电缆接头

### Metal Cable Gland



Thread spec:	PG and Metric
Material:	Parts A.C.F. are made of brass plated with nickel, Part D
	part D is made nylon PA66, parts B and E are made of nitrile butadiene rubber (NBR)
Working temperature:	40 - 100, instantaneous heat resistance up to 120C
Features:	The claws and seals of excellent design, sealing nut have a "click" sound and re-open, can hold cable firmly and have a wider cable range. Resistant to salt water, weak acid, alcohol, oil, grease and common solvency.

Item No.	Thread size	Cable Range Φ(mm)		Thread O.D.	Thread Length	Spanner Size
		常规型	加厚型	L2(mm)	L1(mm)	A&F(mm)
PG7	12.5-12.8	3-6.5	2-5	12.5	8	14
PG9	15.2-15.5	4-8	2-6	15.2	8.2	17
PG11	18.6-18.9	5-10	3-7	18.6	8.2	20
PG13.5	20.4-20.7	6.7-12	5-9	20.4	9	22
PG16	22.5-22.8	10.2-14	7-12	22.5	10	24
PG21	28.3-28.6	13-18	9-16	28.3	10	30
PG29	37-37.3	18.5-25	13-20	37	12	40
PG36	47-47.3	23-32	20-26	47	14	50
PG42	54-54.3	32.7-38	25-31	54	14	57
PG48	59.3-59.6	37-44	29-35	59.3	16.6	64
M12x1.5	12-12.3	3-6.5	2-5	18	8	14
M16x1.5	16-16.3	4-8	2-6	20	8.2	17
M20x1.5	20-20.3	6.7-12	5-9	22	9	22
M25x1.5	25-25.3	13-18	9-16	25	10	30
M32x1.5	32-32.3	18.5-25	13-20	30	12	40
M40x1.5	40-40.3	23-32	20-26	35	14	50
M50x1.5	50-50.3	32.7-38	25-31	38	14	57
M63x1.5	63-63.3	37-44	29-35	40	16.6	64/68





## 定位片

### Cable Tie Mount

Material: 材质:	ABS、Nylon PA66,94V-2,the back attached sponge glue imported 采用 ABS、尼龙 66 制成，防火等级 94V-2. 背附进口双面海绵胶，绝缘性能良好、耐久性、不易老化
Usage: 使用方法:	Peel the sponge glue and stick on the wall then,bundle the wire with cable ties. 将定位片海绵胶撕开，贴于机板固定，再用扎带捆扎电线。
Application: 用途:	for bundling wires and other things save time and convenient,used for the wall which can't be made a hole in. 省时、简便，供面板不可以钻孔时使用。

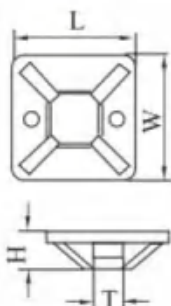

Item No.	LxW	H	T	Screw Hole
	mm	mm	mm	mm
BS-20	20x20	6.1	5.0	2.9
BS-25	25x25	7.5	6.2	3.5
BS-30	30x30	8.7	6.4	4.5
BS-40	40x40	6.4	10.8	4.5

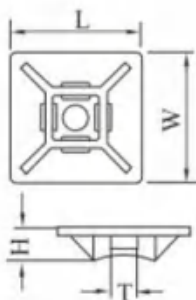

Item No.	LxW	H	T	Screw Hole
	mm	mm	mm	mm
BS-101	22.5x22.5	3.5	4.7	/
BS-102	28x28	4.0	5.0	5.0



## 可调式粘式固定座

### Adjustable Cable Clamp

<p><b>Material:</b> 材质:</p>	<p>UL approved Nylon66,94V-2, the back attached sponge glue imported. UL 认可之尼龙 66 料制成, 防火等级 94V-2。背附进口双面海绵胶。</p>
---------------------------------	--



### •特点 Advantage

这种可调节的塑料电缆夹是固定或半永久安装电缆的理想选择。这个电缆夹上的紧固件有一个梯子式的设计, 使它能够很容易地释放和重新紧固。夹具的底座是自粘的, 便于安装和安全。为了更坚固的固定, 在底座上为 M2 平头螺钉提供安装孔。

this adjustable plastic cable clamp is ideal for securely holding your cables together in permanent or semi-permanent installations. The fastener on this cable clamp has a ladder style design which enables it to be easily released and refastened. The base of the clamp is self-adhesive for easy and secure mounting. For a more robust fixing a mounting hole is provided on the base for an M2 flat head screw

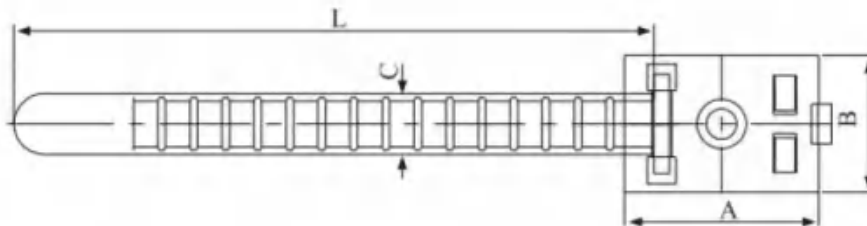

Item No.	A	B	C	L	Max bundle Dia.
	mm	mm	mm	(mm)	mm
ADC-70	25	18		70	17
ADC-90	25	18		90	21
ADC-90B	32	22		90	21



## 配线固定座

### Cable Clamp

Material:  
材质:

UL approved Nylon66,94V-2  
the back attached sponge  
glue imported.  
UL 认可之尼龙 66 料制成, 防  
火等级 94V-2。背附进口双面  
海绵胶。

### •特点 Advantage

电缆夹可适用于各种尺寸的电缆, 组装方便, 快速, 紧密, 可重复使用。

拥有高强度剥离粘接胶垫, 两级锁紧设计, 可同时容纳不同尺寸的电缆。

容易用手指释放重新打开。

The Cable Clamps can be applied to various sizes of cables, assemble easily, rapidly and tightly, to be used repeatedly.

High strength peel and stick adhesive pad Two stage lock design to accommodate different cable sizes in one clamp.

Easy to reopen with thumb tab release.

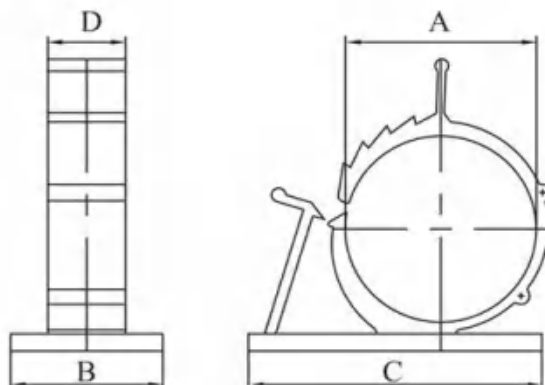

ITEM NO	Dimension (mm)					
	A	B	C	D	E	F
ADP-0810	7.9~10.3	25.4	22.2	19.1	1.6	10.2
ADP-1013	10.0~12.5	31.8	27.8	19.1	1.6	10.2
ADP-1316	12.6 ~15.4	37	31.8	18.4	3	12.1
ADP-1720	16.5 ~20.1	42	37	25	3	12.7
ADP-2225	22.2~25.4	41.8	43.5	21.5	3	11.3



## 扎带固定座

### Cable Tie Holder

Material: 材质:	Made of PA 采用 PA 料制成
Application: 用途:	Suitable for indoor and outdoor installations in various materials, including concrete, brick and wood surfaces. The anchor is installed by driving it into a pre-drilled hole. 适用于室内和室外安装在各种材料中, 包括混凝土, 砖和木材表面。通过将锚插入预先钻好的孔来安装锚。

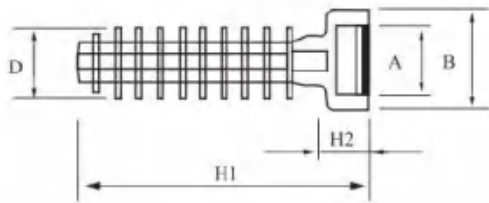

Item No.	A	B	H1	H2	D
	mm	mm	mm	mm	mm
BTH-6	9.6	12.7	37.6	5.85	6.9
BTH-8	9.6	12.3	41.83	6.0	8.78

## 缠绕管

### Spiral Wrapping Bands

Material: 材质:	High quality recycled PE 优质再生尼龙 (PE)
Work temperatures: 温度范围	-80°C ~150°C
Application: 用途:	Special design prevents the fixing rotating in the drill hole. Adapted for wood, self-tapping and chipboard screws. 特殊设计, 防止固定件在钻孔内旋转。 适用于木质、自攻和刨花板螺丝。

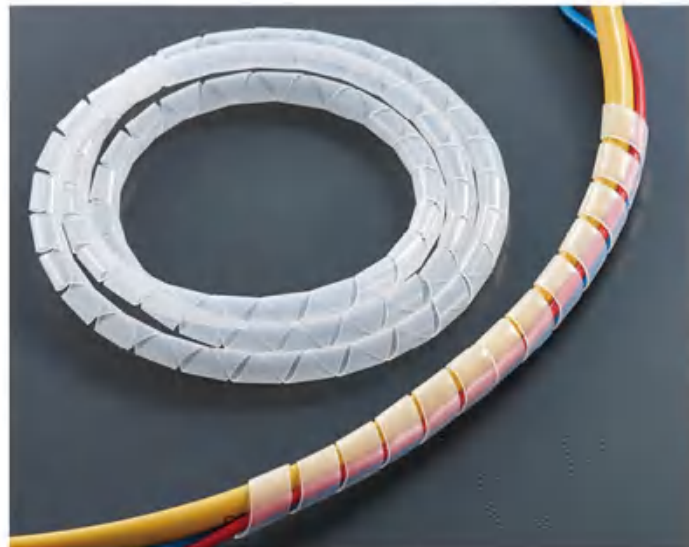

CODE NO.	WRAPPING RANGE (MM)	LENGTH PER ROLL (Meter)	DESCRIPTION (mm)		
			d	D	W
SWB-03	1.5-10	10	1.5	3.0	4.0
SWB-06	4-50	10	4	6	7.0
SWB-08	6-60	10	6	8	10.8
SWB-10	7.5-60	10	7.5	10	11.4
SWB-12	9-65	10	9	12	13.9
SWB-15	12-75	10	12	15	15.0
SWB-19	15-100	10	15	19	18.2
SWB-24	20-130	10	20	24	19.6
SWB-30	26-150	10	26	30	43.0

## R 型夹

### R type Cable Clamp

Material: Nylon 66,94V-2,certificated by UL.  
Usage : after bundling wires, fix them on plate with screw or bolt.

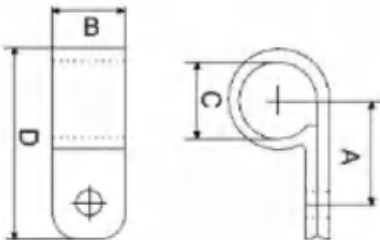

CODE NO.	A(MM)	B(MM)	C(MM)		D(MM)
			MM	INCH	
OK-1/8R	9.5	9.6	3.2	1/8"	19.8
OK-3/16R	9.6	9.6	4.8	3/16"	19.8
OK-1/4R	12	10	6.35	1/4"	22
OK-5/16R	12	10	7.9	5/16"	22
OK-3/8R	12.5	12	9.5	3/8"	24
OK-1/2R	15.2	12	12.7	1/2"	31
OK-5/8R	18.2	12	15.8	5/8"	34.3
OK-3/4R	18.2	12	19.4	3/4"	35
OK-1R	22	12	25.4	1"	43
OK-17/16R	24	12	27	11/16"	45
OK-5/4R	26.5	12	31.8	1 1/4"	46.2
OK-3/2R	30	12	38	1 1/2"	52





## 膨胀管

### Expand Plugs

Material: 材质:	High quality recycled PE 优质再生尼龙 (PE)
Work temperatures: 温度范围	-80°C ~ 80°C
Application: 用途:	Special design prevents the fixing rotating in the drill hole. Adapted for wood, self-tapping and chipboard screws. 特殊设计, 防止固定件在钻孔内旋转。 适用于木质、自攻和刨花板螺丝。

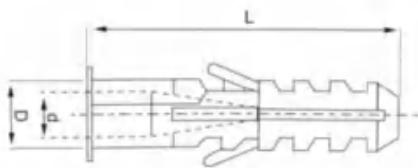

Item No.	L	D	d	Screw	Packing
	mm	mm	mm	mm	
EP-05	25	5	3.7	3.0x25	100pcs/ bag
EP-06	30	6	4.5	4.0x30	
EP-07	35	7	5	4.0x35	
EP-08	35	8	6	4.0x40	
EP-10	40	10	8	4.0x50	
EP-12	48	12	9.6	6.0x60	

### •应用场景 Application scenarios

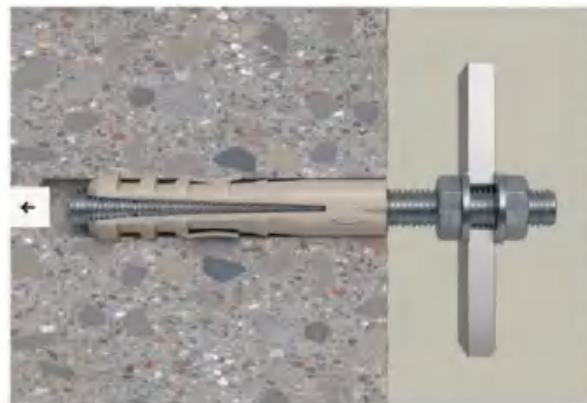
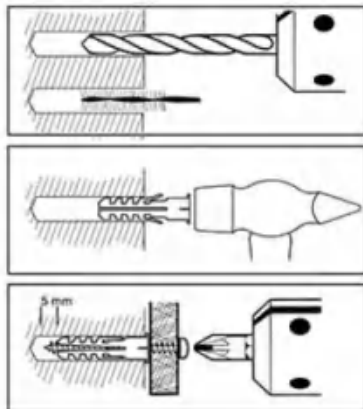

### •适用材质 Applicable to materials



## 安全型压线帽

Safety type Wire Joints

### •描述 Description

外壳材质：UL 认可之尼龙 66，防火等级 94V-2。

使用方法：将电线尾部外皮剥去再插入套管内，用压线钳压紧即可。

特点：外壳为尼龙注塑成型、内部铜管特长，增加电线压接范围使其更易于导电，并更能夹住电线，即使强烈振动亦不脱落。

Shell material: Nylon 66, 94V-2 certificated agree, by UL.

Usage: Peel the coat of wire, then insert to tube, use pincers to fix them.

Feature: Nylon shell long copper tube, easy to conduct electricity and hold wire tightly.

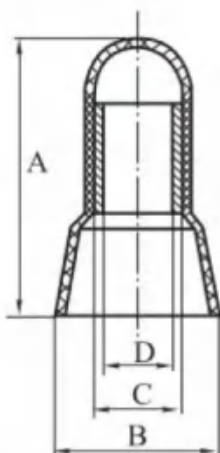

Item No.	H	W	L
CE-1X	18	7	1000
CE-2X	20	9	1000
CE-5X	25	12	500
CE-8	28	14	500
Φ3	17	8	1000
Φ4	18	9	1000
Φ5	21	10	1000
Φ6	24	11	1000
Φ8	25	13	500
Φ10	28	15	500



## 螺旋式压线帽

### Screw On Wire Connectors

#### •描述 Description

材质：采用 UL 认可尼龙 66 料制成，内部备有弹簧。  
使用方法：将电线尾部外皮剥去，将所要接的电线同时插入扭紧即可。

Material: UL Nylon 66 with spring inside.  
Usage: peel wire coat insert wires in, then tighten.

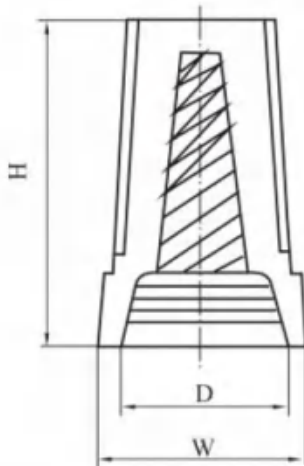

Item No.	H	W	D	Applicable to wire range	Color:
P71	15	8.5	6.5	MIN#20x1+#22*1 MAX#16x2	Gray
P72	18	10	7.5	MIN#20x3 MAX#16x3	blue
P73	20	11.5	9.5	MIN#20x3 MAX#16*3+#18x1	orange
P74	23.5	13.5	10.8	MIN#14*1+#18x1 MAX#14*4+#18x1	yellow
P76	23.5	15.5	12.7	MIN#14x2 MAX#10x2+#12x2	red
P8	32	19	14		red, yellow, gray



## 双翼螺旋式压线帽

Double Wings Screw On Wire Connectors

### •描述 Description

材质：采用 UL 认可尼龙 66 料制成，内部备有弹簧。

使用方法：将电线尾部外皮剥去，将所要接的电线固时插入扭紧即可。

特点：外型设有扭转翼，使操作省力轻便，易于将电线固定。

Material: UL Nylon 66, with spring inside.

Usage: peel wire coat insert wires in then tighten.

Features: the shape is equipped with a torsion wing, so that the operation is labor-saving, easy to fix the wire.

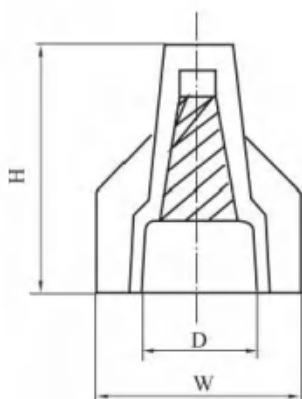

Item No.	H	W	D	Color
SP1	25	18	9	yellow
SP2	29	22	11	red



Item No.	H	W	D	Color
JO-1	26	14	11	yellow
JO-2	26	14	11	red
JO-3	27	15	12	blue
JO-4	28	15	13	gray



## 热收缩套管

### Heat Shrinkable Tubings

Material: 材质:	PVC 高级软质 PVC
Function: 功能:	wire coat and insulation. make the joint of teminal block and wire insulated. devide the colors. water-proof protection and insulation of insistors and electrical capacitors. 电线保护与绝缘 端子与电线接头的绝缘与保护 区分颜色 防水 电阻电容器的保护和绝缘
Color: 颜色:	Standard color Red, blue,yel low,black,green,brown,grey,or ange and purple. 标准颜色红, 蓝, 黄, 黑, 绿, 棕, 灰和紫色



Item No.	As Supplied		After Shrinking		Packing
	内径 I.D(mm)	Thickness(mm)	I.D(mm)	Thickness(mm)	
HST-1	1.0	0.2±0.05	0.5	0.4±0.05	200m/roll
HST-1.5	1.5	0.2±0.05	0.75	0.4±0.05	
HST-2	2.0	0.25±0.05	1	0.45±0.1	
HST-2.5	2.5	0.25±0.05	1.25	0.45±0.1	
HST-3	3.0	0.25±0.05	1.5	0.45±0.1	
HST-3.5	3.5	0.25±0.05	1.75	0.45±0.1	
HST-4	4.0	0.25±0.05	2	0.45±0.1	
HST-5	5.0	0.35±0.05	2.5	0.55±0.1	
HST-6	6.0	0.35±0.05	3	0.55±0.1	
HST-7	7.0	0.35±0.05	3.5	0.55±0.1	
HST-8	8.0	0.35±0.05	4.0	0.55±0.1	

Item No.	As Supplied		After Shrinking		Packing
	内径 I.D(mm)	Thickness(mm)	I.D(mm)	Thickness(mm)	
HST-9	9.0	0.35±0.05	4.5	0.55±0.1	100m/roll
HST-10	10.0	0.35±0.05	5.0	0.6±0.1	
HST-11	11.0	0.35±0.05	5.5	0.6±0.1	
HST-12	12.0	0.35±0.1	6.0	0.7±0.1	
HST-13	13.0	0.35±0.1	6.5	0.7±0.1	
HST-14	14.0	0.35±0.1	7.0	0.7±0.1	
HST-15	15.0	0.35±0.1	7.5	0.7±0.1	
HST-16	16.0	0.35±0.1	8.0	0.7±0.1	
HST-18	18.0	0.4±0.1	9.0	0.8±0.1	
HST-20	20.0	0.5±0.1	10.0	0.9±0.1	
HST-22	22.0	0.5±0.1	11.0	0.9±0.1	
HST-25	25.0	0.5±0.1	12.5	0.9±0.1	50m/roll
HST-28	28.0	0.5±0.1	14.0	0.9±0.1	25m/roll
HST-30	30.0	0.5±0.1	15.0	1.0±0.2	
HST-35	35.0	0.5±0.1	17.5	1.0±0.2	
HST-40	40.0	0.5±0.1	20.0	1.0±0.2	
HST-50	50.0	0.5±0.1	25.0	1.0±0.2	
HST-60	60.0	0.6±0.1	30.0	1.2±0.2	
HST-70	70.0	0.6±0.1	35.0	1.2±0.2	
HST-80	80.0	0.6±0.1	40.0	1.2±0.2	
HST-90	90.0	0.6±0.1	45.0	1.3±0.2	
HST-100	100.0	0.7±0.1	50.0	1.3±0.2	
HST-120	120.0	0.7±0.1	60.0	1.3±0.2	
HST-150	150.0	0.8±0.1	75.0	1.6±0.2	





## 绝缘套管

### Vinyl Wire End Caps

Material: 材质:	PVC 高级软质 PVC
Material: 用途:	Devide the colorful cable in machine, used to various terminals as soft feature, easy to take off. 适用于各种配电盘, 机械中复杂配线之分色处理, 使线路能一目了然。软质弹性适用于各种不同形状的端子, 使用时著脱容易
Color: 颜色:	Standard color Red, blue, yellow, black, green, brown, available upon special request. 红, 蓝, 黄, 黑, 绿, 棕, 特殊颜色可定制

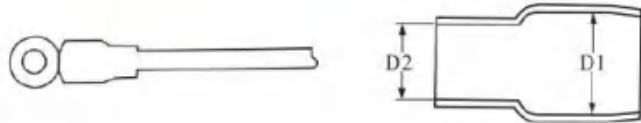

Item No.	SQ			Packing
	mm <sup>2</sup>	D1(mm)	D2(mm)	
V-1.25	1.25	3.3	3.1	100PCS
V-2	2	4.5	3.7	
V-3.5	3.5	5.7	4.1	
V-5.5	5.5	5.7	5.2	
V-8	8	7.2	6.2	
V-14	14	10.0	8.0	
V-22	22	12.0	9.5	
V-38	38	14.0	11.8	
V-60	60	16.8	13.5	
V-80	80	19.0	16.0	
V-100	100	22.0	18.0	50PCS
V-125	125	24.0	20.0	
V-150	150	24.4	22.0	
V-200	200	32.0	24.0	25PCS
V-250	250	38.0	26.5	
V-325	325	38.0	29.0	
V-400	400	44.0	37.0	
V-500	500	45.0	40.4	
V-630	630	52.0	45.0	

## 接线端子

Terminal Block

### •描述 Description

U型接线端子 < 聚乙烯 >

工作温度: -40°C 至 65°C

可选颜色: ○ ● ● ● ● ● ● ●

U Type Terminal Blocks < PE >

Working Temperature: -40°C to 65°C

Color: ○ ● ● ● ● ● ● ●



Item No.	Wire Range	Amp	Volt	L	W	H	E	F	φ	Screw Size	PCS/CTN
				mm							
TB003-01	2.5-4.0mm <sup>2</sup>	3A	380V	91.4	15.6	10.8	7.5	2.5	3.0	M2.5	1000
TB003-02	4.0-6.0mm <sup>2</sup>	6A	380V	112.5	15.5	12.8	9.5	2.9	3.3	M3.0	1000
TB003-03	6.0-10.0mm <sup>2</sup>	10A	380V	128.0	20.6	15.0	10.8	2.9	4.2	M3.0	500
TB003-04	10-12mm <sup>2</sup>	15A	380V	137.3	22.5	16.6	11.5	3.1	4.5	M3.5	500
TB003-05	12-14mm <sup>2</sup>	20A	380V	137.5	22.7	17.7	12.0	3.5	4.7	M4.0	400
TB003-06	16mm <sup>2</sup>	30A	380V	164.5	25.3	19.0	14.2	3.5	5.6	M4.0	300
TB003-07	25mm <sup>2</sup>	60A	380V	185.5	29.2	24.0	15.8	3.5	6.6	M5.0	200
TB003-08	35mm <sup>2</sup>	80A	400V	204.5	32.6	27.2	17.3	4.5	7.0	M5.0	100
TB003-09	40mm <sup>2</sup>	100A	450V	250.0	45.6	30.6	21.5	4.7	9.0	M6.0	50



## 接线端子

Terminal Block

### •描述 Description

H 型接线端子 < 聚乙烯 >

工作温度 : -40°C 至 65°C

可选颜色 : ○ ● ● ● ● ● ● ●

H Type Terminal Blocks < PE >

Working Temperature: -40°C to 65°C

Color: ○ ● ● ● ● ● ● ●

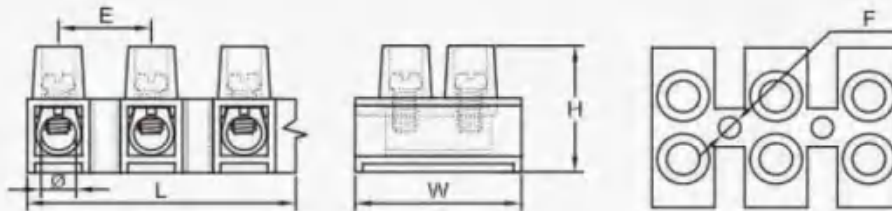

Item No.	Wire Range	Amp	Volt	L	W	H	E	F	φ	Screw Size	PCS/CTN
				mm							
TB001-01	2.5-4.0mm <sup>2</sup>	3A	380V	92.3	16.8	12.3	7.8	2.4	3.0	M2.5	1000
TB001-02	4.0-6.0mm <sup>2</sup>	6A	380V	115.4	18.8	15.4	9.6	2.7	3.3	M3.0	1000
TB001-03	6.0-10.0mm <sup>2</sup>	10A	380V	129.3	20.7	16.5	11.0	2.8	4.2	M3.0	500
TB001-04	10-12mm <sup>2</sup>	15A	380V	137.8	22.5	18.6	11.7	3.1	4.5	M3.5	500
TB001-05	12-14mm <sup>2</sup>	20A	380V	138.0	22.5	19.0	12.0	3.2	4.7	M4.0	400
TB001-06	16mm <sup>2</sup>	30A	380V	164.0	22.5	20.0	13.7	3.4	5.5	M4.0	300
TB001-07	25mm <sup>2</sup>	60A	380V	186.0	29.2	25.3	15.7	3.3	6.6	M4.0	200
TB001-08	35mm <sup>2</sup>	80A	400V	226.8	36.1	29.0	19.2	4.0	8.0	M5.0	100
TB001-09	40mm <sup>2</sup>	100A	450V	254.6	45.0	34.7	20.5	3.7	9.0	M6.0	50



Electrical connector  
Series

接线端子系列





## PVC 绝缘圆形端头

RING VINYL-INSULATED  
TERMINAL(TO-JTK)

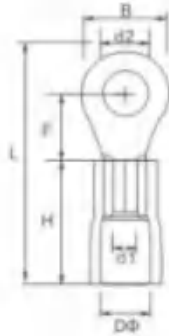

RV NRV



导线截面: 0.5-1.5mm<sup>2</sup> (美国线规 22-16) Cable size:0.5-1.5mm<sup>2</sup> (A.W.G22-16)  
材质: PVC+ 紫铜 Material:PVC+Copper

Item No.	USA SECREW	Screw dia. d2φ	Dimension(mm)					Color
			B	L	F	H	Dφ	
RV1.25-3	#4	3.2	5.7	18.7	4.95	10.6	4.3	Red
RVS1.25-3.5	#6	3.7	5.7	18.7	4.95			
RVSM1.25-3.5	#6	3.7	6.6	19.4	6.3			
RVL1.25-3.5	#6	3.7	8.0	21.2	7.0			
RVS1.25-4	#8	4.3	6.6	19.4	6.3			
RVL1.25-4	#8	4.3	8.0	21.2	7.0			
RVS1.25-5	#10	5.3	8.0	21.2	7.0			
RVL1.25-5	#10	5.3	9.8	23.0	8.5			
RVS1.25-6	1/4	6.4	9.8	23.0	8.5			
RVL1.25-6	1/4	6.4	11.6	26.8	11.1			
RV1.25-8	5/16	8.4	11.6	27.4	11.1			
RV1.25-10	3/8	10.5	13.6	27.4	13.9			
RV1.25-12	1/2	13.0	19.2	37.3	16.5			

导线截面: 1.5-2.5mm<sup>2</sup> (美国线规 16-14) Cable size:1.5-2.5mm<sup>2</sup> (A.W.G16-14)  
材质: PVC+ 紫铜 Material:PVC+Copper

Item No.	USA SECREW	Screw dia. d2φ	Dimension(mm)					Color
			B	L	F	H	Dφ	
RV 2-3	#4	3.2	6.6	17.5	4.3	10.6	4.9	Blue
RVS 2-3.5	#6	3.7	6.6	17.5	4.3			
RVSM 2-3.5	#8	3.7	6.6	20	6.2			

导线截面: 1.5-2.5mm<sup>2</sup> (美国线规 16-14) Cable size:1.5-2.5mm<sup>2</sup> (A.W.G16-14)  
材质: PVC+ 紫铜 Material:PVC+Copper

Item No.	USA SECREW	Screw dia. d2φ	Dimension(mm)					Color
			B	L	F	H	Dφ	
RVL 2-3.5	#8	3.7	8.5	22.8	7.75	10.6	4.9	Blue
RVS2-4	#8	4.3	6.6	20	6.2			
RVL 2-4	#8	4.3	8.5	22.8	7.75			
RVS 2-5	#10	5.3	8.5	22	7.75			
RVL 2-5	#10	5.3	9.5	22.6	7.75			
RVS 2-6	1/4	6.4	11.9	27.2	11			
RV 2-8	5/16	8.4	11.9	27.2	11			
RV 2-10	3/8	10.5	13.6	31.1	13.9			
RV 2-12	1/2	13.0	19.2	36.8	16.5			

导线截面: 2.5-4mm<sup>2</sup> (美国线规 14-12) Cable size:2.5-4mm<sup>2</sup> (A.W.G14-12)  
材质: PVC+ 紫铜 Material:PVC+Copper

Item No.	USA SECREW	Screw dia. d2φ	Dimension(mm)					Color
			B	L	F	H	Dφ	
RV3.5-4	#8	4.3	8.0	24.5	7.7	13.5	6.2	Black
RVS 3.5-5	#10	5.3	8.0	24.5	7.7			
RVL 3.5-5	#10	5.3	12.0	29.0	7.7			
RVL 3.5-6	1/4	6.4	12.0	29.0	7.7			

导线截面: 4-6mm<sup>2</sup> (美国线规 12-10) Cable size:4-6mm<sup>2</sup> (A.W.G12-10)  
材质: PVC+ 紫铜 Material:PVC+Copper

Item No.	USA SECREW	Screw dia. d2φ	Dimension(mm)					Color
			B	L	F	H	Dφ	
RV 5.5-3.5	#6	3.7	7.2	22	5.3	13.5	6.7	Yellow
RVS 5.5-4	#8	4.3	7.2	22	5.3			
RVL 5.5-4	#8	4.3	9.5	26.2	8.25			
RV 5.5-5	#10	5.3	9.5	26.2	8.25			
RVS 5.5-6	1/4	6.4	12.0	32.1	10.7			
RVL 5.5-6	1/4	6.4	12.0	32.8	13			
RV 5.5-8	5/16	8.4	15.0	34	13.7			
RV 5.5-10	3/8	10.5	15.0	34	13.7			
RV 5.5-12	1/2	13.0	19.2	38.8	16			





## PVC 绝缘叉形端头

SPADE VINYL-INSULATED  
TERMINAL(TU-JTK)

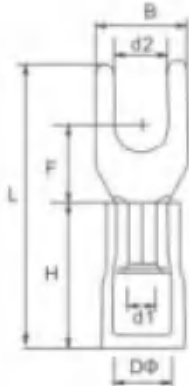

导线截面: 0.5-1.5mm<sup>2</sup> (美国线规 22-16) Cable size:0.5-1.5mm<sup>2</sup> (A.W.G22-16)  
材质: PVC+ 紫铜 Material:PVC+Copper

Item No.	USA SECREW	Screw dia. d2φ	Dimension(mm)						Color
			B	L	F	H	Dφ	T	
SV 1.25-3	#4	3.2	5.7	21.6	6.5	10	4.3	0.7	Red
SVS 1.25-3.5	#6	3.7	5.7	21.6	6.5				
SVL 1.25-3.5	#6	3.7	6.4	21.2	6.5				
SVS 1.25-4	#8	4.3	8	21.2	6.5				
SVM 1.25-4	#8	4.3	7.2	21.2	6.5				
SVL 1.25-4	#8	4.3	8.1	21.2	6.5				
SVS 1.25-5	#10	5.3	8.1	21.2	6.5				
SVL 1.25-5	#10	5.3	9.5	21.2	6.5				
SVS 1.25-6	1/4	6.4	9.5	21.2	6.5				
SVL 1.25-6	1/4	6.4	12.0	27.2	11.0				

导线截面: 1.5-2.5mm<sup>2</sup> (美国线规 16-14) Cable size:1.5-2.5mm<sup>2</sup> (A.W.G16-14)  
材质: PVC+ 紫铜 Material:PVC+Copper

Item No.	USA SECREW	Screw dia. d2φ	Dimension(mm)						Color
			B	L	F	H	Dφ	T	
SV 2-3	#4	3.2	6.5	21.6	5.7	10.6	4.9	0.8	Blue
SVS 2-3.5	#6	3.7	6.5	21.2	5.7				
SVL 2-3.5	#6	3.7	6.5	21.2	6				
SVS 2-4	#8	4.3	6.5	21.2	6.4				
SVM 2-4	#8	4.3	6.5	21.2	7.2				

导线截面: 1.5-2.5mm<sup>2</sup> (美国线规 16-14) Cable size:1.5-2.5mm<sup>2</sup> (A.W.G16-14)  
材质: PVC+紫铜 Material:PVC+Copper

Item No.	USA SECREW	Screw dia. d2φ	Dimension(mm)						Color
			B	L	F	H	Dφ	T	
SVL 2-4	#8	4.3	6.5	21.2	8.1	10.6	4.9	0.8	Blue
SVS 2-5	#10	5.3	6.5	21.2	8.1				
SVL 2-5	#10	5.3	6.5	21.2	9.5				
SVS 2-6	1/4	6.4	6.5	21.2	9.5				
SVL 2-6	1/4	6.4	11.0	27.8	12.0				

导线截面: 2.5-4mm<sup>2</sup> (美国线规 14-12) Cable size:2.5-4mm<sup>2</sup> (A.W.G14-12)  
材质: PVC+紫铜 Material:PVC+Copper

Item No.	USA SECREW	Screw dia. d2φ	Dimension(mm)						Color
			B	L	F	H	Dφ	T	
SV 3.5-3	#4	3.2	7.0	26.8	5.7	13	6.2	1.0	Black
SV 3.5-4	#8	4.3	7.0	24.8	8				
SV 3.5-5	#10	5.3	7.0	24.8	8				
SV 3.5-6	1/4	6.4	12.1	28.3	12.1				

导线截面: 4-6mm<sup>2</sup> (美国线规 12-10) Cable size:4-6mm<sup>2</sup> (A.W.G12-10)  
材质: PVC+紫铜 Material:PVC+Copper

Item No.	USA SECREW	Screw dia. d2φ	Dimension(mm)						Color
			B	L	F	H	Dφ	T	
SV 5.5-3.5	#6	3.7	7.5	26	8.4	13.0	6.7	1.0	Yellow
SVS 5.5-4	#8	4.3	7.5	26	8.4				
SVL 5.5-4	#8	4.3	7.5	26	9.0				
SV 5.5-5	#10	5.3	7.5	26	9.0				
SVS 5.5-6	1/4	6.4	7.5	26	9.0				
SVL 5.5-6	1/4	6.4	12.0	32	12.0				
SV 5.5-8	5/16	8.4	11.5	31	14.0				



## 母预绝缘端头

### VINYL-INSULATED FEMALE DISCONNECTORS

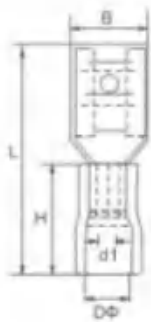

Material:PVC+Brass		材质: PVC+ 黄铜		
Item No.	Connecting spec. (mm)	Thickness of material	AWG	Color
FDD 1.25-110(5)	0.5x2.8	0.3	22-16	Red
FDD 1.25-110(8)	0.8x2.8	0.3		
FDD 1.25-187(5)	0.5x4.75	0.35		
FDD 1.25-187(8)	0.8x4.75	0.35		
FDD 1.25-205	0.5x5.2	0.35		
FDD 1.25-250	0.8x6.35	0.4		
FDD 2-110(5)	0.5x2.8	0.3	16-14	Blue
FDD 2-110(8)	0.8x2.8	0.3		
FDD 2-187(5)	0.5x4.75	0.35		
FDD 2-187(8)	0.8x4.75	0.35		
FDD 2-205	0.5x5.2	0.35		
FDD 2-250	0.8x6.35	0.4		
FDD 5.5-250	0.8x6.35	0.4	12-10	Yellow
FDD 5.5-375	1.2x9.4	0.5		

## 子弹形公预绝缘端头

### VINYL-INSULATED BULLET DISCONNECTORS

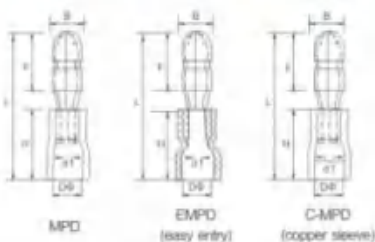

EASY ENTRY AND COPPER SLEEVE (易进式和铜套)					
Material:PVC+Brass 材质: PVC+ 黄铜					
Item No.			Thickness of material	AWG	Color
MPD 1.25-156	EMPD 1.25-156	C-MPD 1.25-156	0.4	22-16	Red
MPD 2-156	EMPD 2-156	C-MPD 2-156	0.4	16-14	Blue
MPD 2-195	EMPD 2-195	C-MPD 2-195	0.4		
MPD 5.5-195	EMPD 5.5-195	C-MPD 5.5-195	0.4	12-10	Yellow



## 公预绝缘端头

### VINYL-INSULATED MALE DISCONNECTORS



#### EASY ENTRY AND COPPER SLEEVE (易进式和铜套)

Material: PVC+Brass 材质: PVC+ 黄铜

Item No.			Nema Tab(mm)	Thickness of material	AWG	Color
MDD1.25-110(5)	EMDD1.25-110(5)	C-MDD1.25-110(5)	0.5x2.8	0.5	22-16	Red
MDD1.25-110(8)	EMDD1.25-110(8)	C-MDD1.25-110(8)	0.8x2.8	0.8		
MDD1.25-187(5)	EMDD1.25-187(5)	C-MDD1.25-187(5)	0.5x4.75	0.5		
MDD1.25-187(8)	EMDD1.25-187(8)	C-MDD1.25-187(8)	0.8x4.75	0.8		
MDD1.25-250	EMDD1.25-250	C-MDD1.25-250	0.8x6.35	0.4x2	16-14	Blue
MDD 2-187(5)	EMDD 2-187(5)	C-MDD 2-187(5)	0.5x4.75	0.5		
MDD 2-187(8)	EMDD 2-187(8)	C-MDD 2-187(8)	0.8x4.75	0.8		
MDD 2-250	EMDD 2-250	C-MDD 2-250	0.8x6.35	0.4x2	12-10	Yellow
MDD 5.5-250	EMDD 5.5-250	C-MDD 5.5-250	0.8x6.35	0.4x2		

## 母全绝缘接头

### VINYL FULLY INSULATED FEMALE DISCONNECTORS



导线截面: 0.5-1.5mm<sup>2</sup>(美国线规 22-16) Cable size: 0.5-1.5mm<sup>2</sup>(A.W.G22-16)

材质: 紫铜 Material: Copper

ITEM NO.	Nema Tab (mm)	Dimension(mm)				AWG
		B	Dφ	dφ	L	
FDFD1.25-187(5)	0.5x4.75	5.6	3.8	1.7	20.8	22-16
FDFD1.25-187(8)	0.8x4.75	5.6	3.8	1.7	20.8	
FDFD1.25-250	0.8x6.35	7.4	3.8	1.7	24.3	
FDFD 2-187(5)	0.5x4.75	5.6	4.3	2.3	20.8	
FDFD 2-187(8)	0.8x4.75	5.6	4.3	2.3	20.8	
FDFD 2-250	0.8x6.35	7.4	4.3	2.3	24.3	
FDFD 5.5-250	0.8x6.35	7.4	5.7	3.4	24.3	



## 子弹形母预绝缘接头

### VINYL FULLY INSULATED RECEPTACLE DISCONNECTORS



导线截面: 0.5-1.5mm<sup>2</sup>(美国线规 22-16) Cable size:0.5-1.5mm<sup>2</sup>(A.W.G22-16)  
 材质: 紫铜 Material:Copper

ITEM NO.	Thickness of material	Dimension(mm)					Color	AWG
		bφ	Bφ	Dφ	F	L		
FRD 1.25-156	0.4	4.0	6.3	1.7	13.0	24.5	Red	22-16
FRD 2-156	0.4	4.0	6.3	2.3	14.0	24.5	Blue	
FRD 2-195	0.4	5.0	7.0	2.3	14.0	25.5		
FRD 5.5-195	0.4	5.0	7.0	3.4	14.0	25.2	Yellow	

## 肩背形公母预绝缘端头

### VINYL-INSULATED PIGGY-BACK DISCONNECTORS



材质: PVC 和黄铜

Material: PVC+Brass

Item No.			Nema Tab(mm)	Dimension(mm)					
				B	B1	H	Dφ	dφ	L
PBDD 1.25-250	EPBDD 1.25-250	C-PBDD 1.25-250	0.8x6.35	7.4	6.3	10.6	3.8	1.7	21.0
PBDD 2-250	EPBDD 2-250	C-PBDD 2-250	0.8x6.35	7.7	6.3	10.6	4.3	2.3	21.0
PBDD 5.5-250	EPBDD 5.5-250	C-PBDD 5.5-250	0.8x6.35	7.7	6.3	13.5	5.7	3.4	23.5

## 长形全绝缘中间接头

VINYL-INSULATED BUTT SPLICE TERMINAL(TL-JTK)



材质：紫铜 Material:Copper							
ITEM NO.	Conductor section		Dimension(mm)			lmax	Color
	AWG	mm <sup>2</sup>	l	dφ	L		
BV 1.25	22-16	0.5-1.5	15.0	1.7	25.0	19A	Red
BV 2	16-14	1.5-2.5	15.0	2.3	25.0	27A	Blue
BV 5.5	12-10	4-6	15.0	3.4	25.0	48A	Yellow
BV 8	#8	6-10	21.0	4.5	32.0	62A	Red
BV 14	#6	10-16	26.0	5.8	42.0	88A	Blue
BV 22	#4	16-25	29.0	7.7	50.0	115A	Yellow
BV 38	#2	35-50	32.0	9.4	55.0	160A	Red

## 长形全绝缘中间接头(尼龙)

LONG FULL INSULALATING MIDDLE JOINT(NYLON)

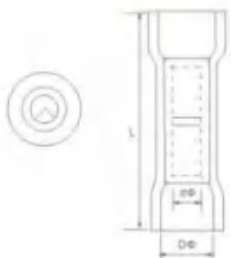

材质：紫铜 Material:Copper					
ITEM NO.	Dimension(mm)			AWG(mm)	Color
	L	Dφ	dφ		
BNY 1.25	27.3	3.2	1.7	22-16A.W.G 0.5-1.5mm <sup>2</sup>	Red
BNY 2	27.3	3.8	2.3	16-14A.W.G 1.5-2.5mm <sup>2</sup>	Blue
BNY 5.5	27.3	5.3	3.4	12-10A.W.G 4-6mm <sup>2</sup>	Yellow



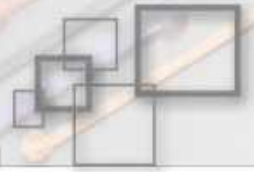

## 旗形母绝缘接头(尼龙)

FLAG FEMALE INSULALATING JOINT(NYLON)

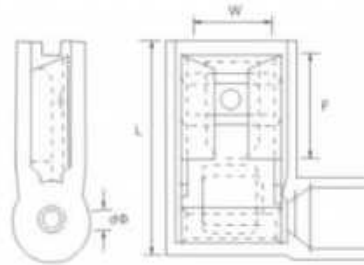

		材质: 紫铜		Material: Copper			
ITEM NO.	Connect Specification	Dimension(mm)				AWG(mm)	Color
		W	F	L	dφ		
FLDNY 1.25-250	0.8x6.35	6.6	7.6	16	17	22-16A.W.G 0.5-1.5mm <sup>2</sup>	Red
FLDNY 2-250	0.8x6.35	6.6	7.6	16	17	16-14A.W.G 1.5-2.5mm <sup>2</sup>	Blue
FLDNY 5.5-250	0.8x6.35	6.6	7.6	16	17	12-10A.W.G 4-6mm <sup>2</sup>	Yellow

## 乐清市博实电塑有限公司

Yueqing Boese Electronic Plastic Co., Ltd.

---

地址：浙江省乐清市北白象镇中方智能园区中方路 66 号  
Add: NO.66 Zhongfang Road, Zhongfang Industrial Zone  
North Baixiang ,Wenzhou , Zhejiang, China  
电话 /Tel: 86-577-61890088 61890666  
传真 /Fax: 86-577-61890088  
Whatsapp: 86-15057518080 86-13777772066  
Http: //www.boese.com.cn www.nylon-cabletie.com  
E-mail: boese@boese.com.cn  
sales2@nylon-cabletie.com  
邮编 /P.C: 325603



扫描浏览电子样本